

SPDV2133.102

Six digit dcf clock

with 4x20mm + 2x14mm blue 7 segment LED displays
and temperature
and extra antenna

Handbook

Version: Firmware 1.79-145



©StefPro™



StefPro UG (haftungsbeschränkt) & Co. KG

Theilenmoorstr. 11
26345 Bockhorn, Germany

Phone: +49-4452-709175

Web: <https://www.stefpro.biz/>

E-mail: info@stefpro.biz

Handbook Version 1.0.0 - Valid from 10.01.2018.

Table of Contents

Table of Contents	2
Safety	4
Application and function description	5
Function description	5
Technical data	6
Construction description	6
Installation of the device (Dimensions)	6
Connectors	6
X-DC : DC Power input : Print plug 2 pole	7
X-DCF : DCF input, DCF PowerSave output: Print connector 5 pin	7
Properties of the components	8
DCF module properties	8
Tested modules	8
Our standard color coding for DCF signals	8
Power supply properties	8
Installation the DCF clock	10
Synchronize with active display	10
Synchronize with deactivated display	10
Button description	12
Overview of buttons	12
Button functions	12
Menu	12
Normal	13
Display mode of clock	13
Show Temperature	13
Alarm	13
Alarm enable	14
Alarm time hour	14
Alarm time minute	14
Alarm snooze time	14
Alarm sound wait time	14
Alarm maximum time	14
Alarm exit	15
Brightness	15
Brightness menu	15
Brightness max	15
Brightness min	15
Brightness automatically	15
Brightness speed	16
Brightness factor	16
Brightness offset	16
Activate standby	16
StandBy start hour	16
StandBy end hour	17
StandBy Brightness	17
Exit brightness settings	17
DCF	17
DCF active	17
Receiving brightness	17
Hour of synchronization	18
Receive state display	18
DCF input pull up	18
DCF input invert	18
Power save pin invert	19
DCF sensitivity	19
DCF exit	19
Clock Settings	19
Set hour	19
Set minute	19
Set year	20
Set month	20
Set day	20
Day of week	20

Set time	21
Calibrate quartz	21
Exit clock settings	21
Info section	21
IC number	21
Firmware version	21
Menu end	22
Attachment	23
Bootloader handling	23
Start the IC/module/device in bootloader mode	23
Use the Firmware Upload Tool to upload an update	23
7 segment characters	24
Change log	24
Safety	24
DCF module properties	24
Power supply properties	25
Temperature sensor	25
Set day	25
Liability, warranty and copyright notice	26
Definitions	26
Liability	26
Safety Notes	26
Intended operation	26
Warranty	26
Copyright notice	26
Disposal information	28
Impress	28

Safety

Follow the manual



The device is only safe in operation if all instructions are read in this handbook.

General understanding of safety

By the device there are no hazard under normal use.

Intended Use

The module is designed for driving small to middle displays.

The power should come from a safe transformer (also protected transformer) or a corresponding low voltage power supply for the circuit.





Never use a higher voltage or direct mains voltage!

Concealed Hazards



DANGER

following hazards may arise in case of wrong construction of the circuit and wrong handling of device:

-  With the direct connection to mains, it's a dangerous voltage on the module and other components, use a safety transformer!
-  Reverse polarity and overloading the device may cause in smoke. This smoke possibly contains toxic substances which must not be inhaled! Ventilate the room.
-   Reverse polarity or overload of the device can cause a hot surface on the IC or other component in the circuit.
 - There is a risk of burning when touching.
 - And flammable materials, for example Paper, can come in fire.
-  Despite careful examination, the housing parts can still be sharp and sharp! Therefore, they can cause wounds if handled incorrectly.

Modifications of the example circuit

Check as appropriate all housing part and lines for damage. This applies in particular to parts of the directly (for example power cord and power supply) or indirectly come into contact with mains voltage.

Application and function description

Function description

This IC can analyze the DCF77 signal, which is received by a receiver and demodulated. The received time and date can output directly to a 7-segment displays. The clock synchronizes itself automatically once a day. The hour of the synchronization can be set in the menu.

The time is displayed according to DIN 5008, which means a leading 0 at the hour. 8 a.m. looks like 08:00:00 and 8 p.m. 20:00:00

Due to the 6-digit display, the date is not shown according to DIN 5008. The 24 December 2020 looks on the display like 24.12.20.

The DCF77 signal is a low frequency radio signal which transferred the time and date. It will be sent in Frankfurt am Main, derived of the local atomic clock and sent with the carrier frequency of 77.5 kHz. Therefore, these watches are also known as radio clock.

The input for the DCF77 antenna can now automatically detect whether a pullup resistor is required and whether the input has to be inverted.

Even a simple alarm function is implemented.

This IC also has an adjustable brightness control for the display, thereby the display is easy to read during the day and at night it does not light out the entire room.

With this IC the **temperature** will be displayed alternately with the time and or date.

This IC has a bootloader, which allows you to update the IC firmware. This means that you will always remain at the current state of the Firmware for the IC, without further costs.

Technical data

- Operating voltage: 9 - 12 volts DC
- Current: 200mA
- Power: approximately 1.8 W (at 9 volts)
- Volume level of the buzzer: approx. 85 to 90 DB

Construction description

Installation of the device (Dimensions)

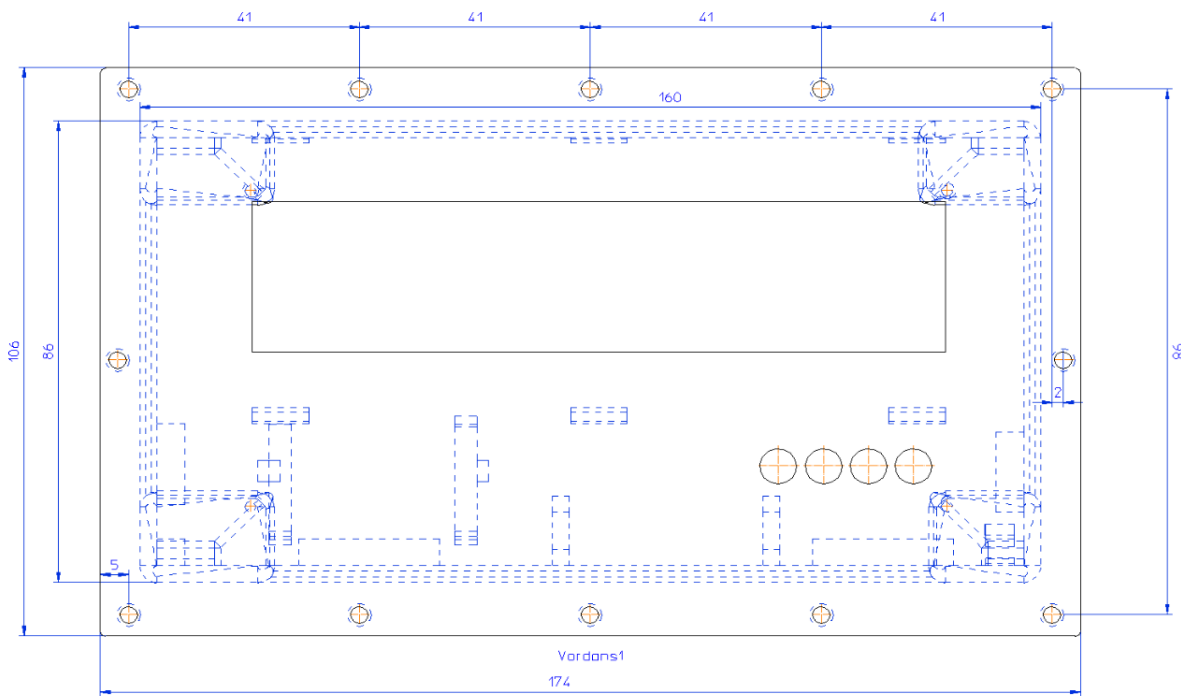

Figure 1: Installation (Dimensions) description for device SPH2305.1

Mount the device, e.g. in a wall to cover the back. Use M3 screws for fastening. Make sure that there is no metallic area on the back where pins of the module can contact it.

Connectors

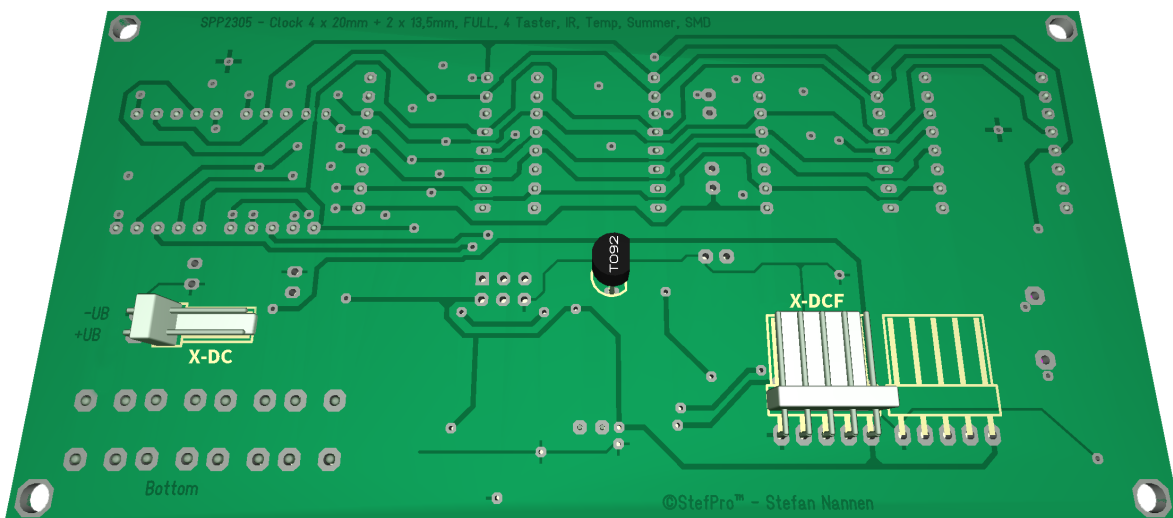



Figure 1: Connector description for device SPH2305.1

Pin assignment see X-DC and X-DCF.

 Make sure that you have connected all signals correctly. There is no overload and polarity protection!

X-DC : DC Power input : Print plug 2 pole



Pin	Name	Direction	Function	Maximum
1	GND	Power		
2	V+	Power	Power supply input of the module	9 - 12 volts DC, 200mA

X-DCF : DCF input, DCF PowerSave output: Print connector 5 pin

Pin	Name	Direction	Function	Maximum
1	GND	Power		
2	N.C.		Do not connect	VCC
3	DCF in	Digital input	<u>DCF</u> signal input	VCC
4	DCF ps	Digital Output	<u>DCF</u> PowerSave output	VCC
5	VCC	Power		5 volts DC, 30mA

Properties of the components

DCF module properties

- The module has to be able to work with an operating voltage of 5V (some modules have an operating voltage range of 1.2 to 15 volts, these are also usable)
- The output has to be able to drive a CMOS input with a input impedance of 10kΩ
- For DCF modules with open collector (open collector) or open drain output the input detected automatically by default whether a pull-up resistor is required. In menu a pull-up resistor can be connected or disconnected permanently.
- Polarity of the output:
 - The output has to be non inverting, the high  state has to be 100ms or 200ms
 - The output has to be inverting, the low  state has to be 100ms or 200ms
 - The receiving LED should at good reception signal flash every second for 100 ms and 200 ms. Does the receiving LED goes off every second for 100 ms and 200 ms, then the polarity is wrong. Unfortunately, you then connected a wrong module, this can't be analyzed with the microcontroller.
 - Whether the output is non inverting or inverting, is detected automatically by default or can be set in the menu.
 - The receiving LED should at good reception signal flash every second for 100 ms and 200 ms. Does the receiving LED goes off every second for 100 ms and 200 ms, then the polarity is wrong. To correct this, you has to be invert the setting for the inverting DCF input pin in the menu. (Instead of on → off → on or off)
- The DCF module can have a power on / off pin. Then the DCF module is automatically switched off when the DCF signals from the microcontroller are not analyzed. In the menu can be set if the DCF module is with low or high on.

Tested modules

Module	GND	VCC	DCF input	PowerSave output	Comment
Conrad DCF Modul	1 (GND)	2 (Betriebs...)	3 (DCF Ausgang)	-	
ELV DCF Modul	3 (Masse)	1 (+ UB)	2 (Signal-Ausgang)	-	
Pollin DCF Modul	GND	VCC	DATA	PON	Caution An additional circuit is required for an operating voltage of more than 3.3V!

Our standard color coding for DCF signals

- GND: black
- VCC: rot
- DCF input: green
- PowerSave output: white (is not supported by each DCF receive module)

WARNING

Please check the pin assignments! It is not in our hands whether the manufacturers of the DCF receive modules change the pin assignments at a later date.

Power supply properties

Since the clock is usually to be operated on a 230 volt power supply, a power supply unit is required. This can be a normal transformer power supply or a switching power supply.

Transformer power supply:

- Pro:
 - Cheap
 - Little interference for DCF reception
- Contra:
 - Heavy
 - Depending on the power is it big
 - Poor efficiency
 - Even if the circuit requires little power, some power may be needed
 - Higher electricity costs

Switching Power Supply:

- Pro:
 - Light
 - Small
 - Good efficiency is possible
 - Standby possible with very low power requirements
 - Lower electricity costs than with the transformer power supply

- Contra:
 - Larger interference for DCF reception
 - Usually a little more expensive

Switching power supplies should be preferred, unfortunately they have the disadvantage that many can interfere with the DCF reception and the DCF clock is not synchronized. Switching power supplies with a PE feedthrough (PE is connected to ground) often have better interference behavior, but this cannot be generalized. The switching power supplies offered in our shop have been tested and only minimally interfere with DCF reception.

WARNING

Use only a power supply unit with electrical isolation!

Installation the DCF clock

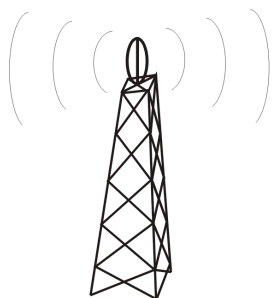

Sender in Frankfurt



DCF77-Antenne

Figure 2: Align the DCF antenna

The external antenna receives the DCF77 signal and should be directed to Frankfurt, as shown in Figure 2. The antenna should be placed at least 1 meter away from a monitor, computer or other disturbing electronic devices .



During installation, the receiving LED can be used as an orientation to the quality of reception. The LED should flash at intervals of one second. If the antenna is properly aligned and the signal is strong enough, the display changes of „no signal,, (No impeccable DCF77 signal) in „SEArCH,, (search for the 59th second). Was the 59th second found so will the display shows „rEAd60,, (read the DCF time) henceforth. It still takes 60 seconds to display the correct time. If the clock is not synchronized to the DCF time, the receiver LED flashes DCF work cycle (power reserve is in operation), if the LED is enabled in the menu. Is the display not changed to „SEArCH,, the antenna is probably disturbed by a device or the antenna is too close to the display. Because the DCF antenna is so sensitive that it can disturb by the display in the near field, there is the possibility to reduce the brightness of the display during the synchronization, or to deactivate the display. This problem have all other DCF clocks with multiplexed LEDs displays also. By a darker display the DCF antenna can be mounted significantly closer to the display.

Synchronize with active display

This mode is active when in menu under "receive brightness" the brightness is set > 0. Appearance of the text on the screen:



Synchronize with deactivated display

This mode is active when in menu under "receive brightness" the brightness is set to 0. When synchronizing with disabled display, only one decimal point for orientation appears.





„**SEArCH**„ Search the fifty-ninth second.



„**rEAdXX**„ read the dcf time.

Button description

Overview of buttons



Button functions

Menu+	Opens the menu, next setting
Menu-	Opens the menu, previous setting
Plus	Function key, in general + or on
Minus	Function key, in general - or off

To open the menu you have to press one of the menu buttons. Use the menu+ button to navigate forward and the menu- button to navigate backward.

Menu

Level 1	Level 2
Normal ↓	
Display mode of clock ↓	
Show Temperature ↓	
Alarm ↓	Alarm enable → Alarm time hour → Alarm time minute → Alarm snooze time → Alarm sound wait time → Alarm maximum time → Alarm exit ☺
Brightness ↓	Brightness menu → Brightness max → Brightness min → Brightness automatically → Brightness speed → Brightness factor → Brightness offset → Activate standby → StandBy start hour → StandBy end hour → StandBy Brightness → Exit brightness settings ☺
DCF ↓	DCF active → Receiving brightness → Hour of synchronization → Receive state display → DCF input pull up → DCF input invert → Power save pin invert → DCF sensitivity → DCF exit ☺
Clock Settings ↓	Set hour → Set minute → Set year → Set month → Set day → Day of week → Set time → Calibrate quartz → Exit clock settings ☺
Info section ↓	
IC number ↓	
Firmware version ↓	

⏏: Next step in main menu.

➡: Next step in sub menu.

🔄: The submenu starts again.

Normal

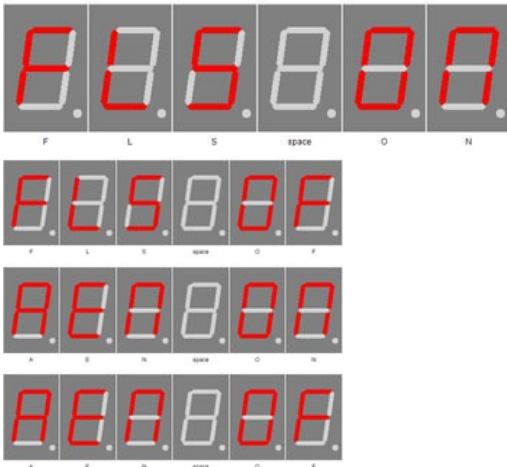

Normal mode, outside of the menu.

Here the + button has the function of the alarm temporary switch on or off.

The - button Switches the display to 100% (flashlight).

Display mode of clock



Time

Date

Time & Date

Sets the mode how to display time and date.

- OF: Does not display the time / date. When the temperature display is active, the temperature is displayed continuously. If no temperature display is possible or active, dashes (-) are shown in the display.
- ti: Shows only the time.
- dA: Shows only date.
- td: Shows time and date alternately.

Show Temperature

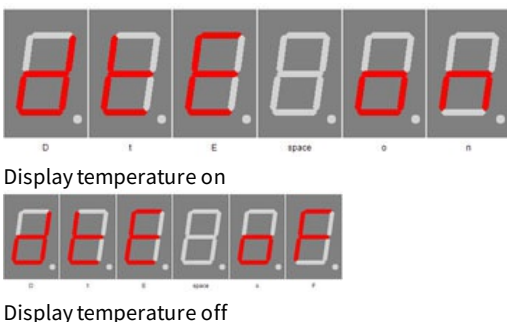

Display temperature on

Display temperature off

Enables the temperature display.

Long press + activates the calibration via temperature input, long press - activates the calibration via offset value. You can find more information in the chapter "Temperature sensor" - "Method of calibration ...".

Alarm

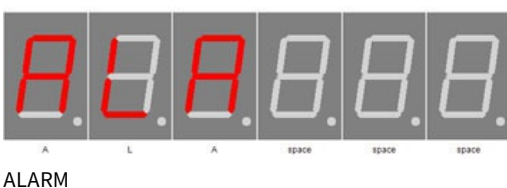

ALARM

With + you enter the sub-menu Alarm.

Alarm enable

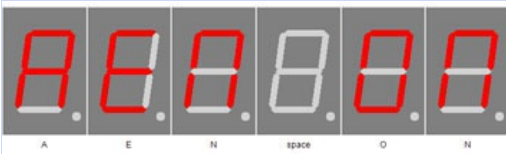

ALARM ON

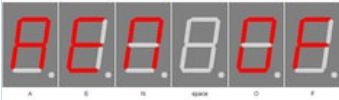

ALARM OFF

Enables the alarm.

Alarm time hour

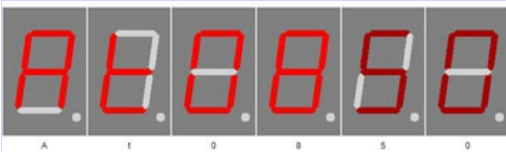

Alarm hour

Sets the hour for alarm. The number can be 0-23

Alarm time minute

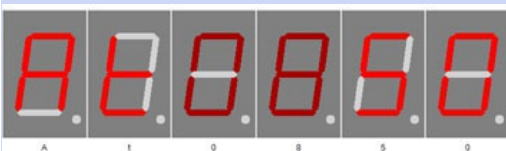

Alarm minute

Sets the minutes for alarm. The number can be 0-59

Alarm snooze time



Alarm snooze time

Sets the minutes for the snooze function. The number can be 1-30

NOTICE

If "alarm maximum time" is shorter than alarm snooze time, the snooze function is disabled!

Alarm sound wait time



Alarm sound delay

Sets the maximum time in minutes for the alarm. The number can be 0-10.

NOTICE

If "Alarm sound delay" greater selected as maximum alarm time, then the display is only set to 100% brightness! No buzzer alarm!

Alarm maximum time



Alarm after time

Sets the maximum time in minutes for the alarm. The number can be 2-60.

Alarm exit

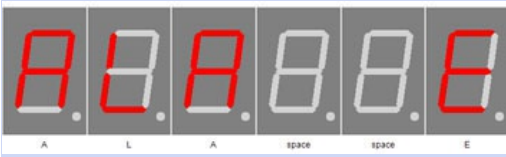

Alarm exit

With + you exit the sub-menu alarm.

Brightness

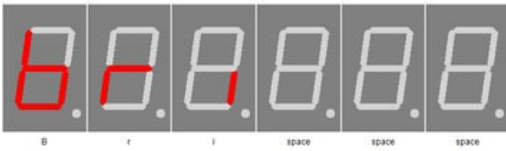

Brightness

With + you enter the sub-menu brightness.

Brightness menu



Brightness

Sets the brightness of the menu. The number can be 10-25

Brightness max



Brightness high

In this menu item, the maximum brightness of the display can be adjusted.

This is also used when auto brightness is disabled.

The number can be 0-25

Brightness min



Brightness low

In this menu item, the minimum display brightness can be adjusted.

The number can be 0-25

Brightness automatically



Brightness automatically on



Brightness automatically off

This allows to turn on and off auto brightness.

Brightness speed

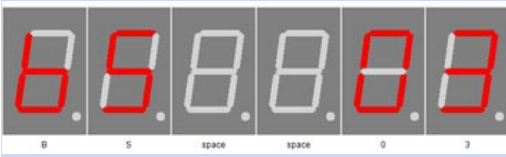

Brightness speed

This sets the speed of auto brightness.

The number can be 0-20. The maximum value may differ depending on the firmware.

Brightness factor



Brightness factor

This sets the calculation factor for auto brightness.

The number can be 1-99

Brightness offset



Brightness offset

This sets the calculation offset for auto brightness.

The number can be -99 - 99



Brightness offset -99



Brightness offset +99

Activate standby



StandBy (Powersave) Enable On

Activates standby mode, in which the display is switched off. The clock and alarm function are still available, the time, date or temperature are simply not displayed.

Through the flashlight function can this interrupted.



StandBy (Powersave) Enable Off

StandBy start hour



StandBy (Powersave) Start Hour

The standby operation starts from this hour. Only full hour can be set.

The range is from 0 (midnight) to 23 (11pm).

Hour of synchronization



DCF synchronize hour



DCF synchronize hour disabled

Sets the hour in which the DCF clock will synchronize. In this hour, the DCF signal will be analyzed until a synchronization has occurred or the hour changes.

The number can be 0-23.

If the display shows "--" instead of a number, the synchronization hour has been deactivated and the dcf receiver is constantly trying to synchronize. In this case, the receipt display can also be displayed permanently.

Receive state display

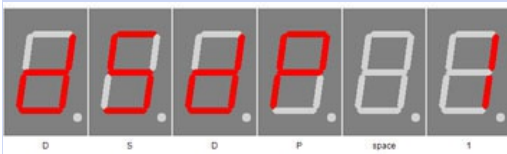

DCF status decimal point display

Sets the mode for the receive LED, which shows the received signal. The number can be 0-2.

- 0: Only until the clock has been synchronized.
- 1: Shows the received signal when the clock is not synchronized with the DCF77 signal.
- 2: During the synchronization phase, the receive signal is always on the receive LED regardless of the DCF77 synchronization flag.

Only while the clock is trying to receive the DCF signal, see "Hour of synchronization".

DCF input pull up

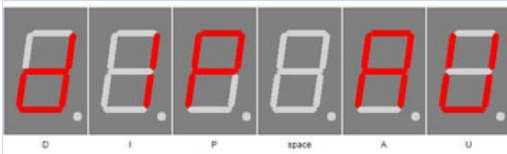

DCF input pull up auto



DCF input pull up on



DCF input pull up off

DCF77 input pin with pullup

- AU: Pull Up is automatically (default).
AU is activated by pressing the + button.
- ON: Enables the pull-up resistor
- OFF: Disables the pull-up resistor
ON and OFF is activated and toggled by the - button.
- Conrad DCF module = ON
- ELV DCF module = ON
- Pollin DCF module (3.3 V) = OFF

No guarantee for correctness of the information and changes of the manufacturer.

DCF input invert

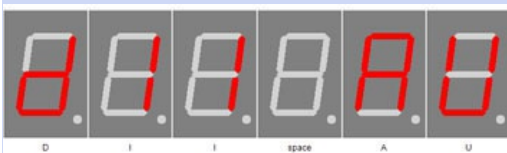

DCF input invert auto



DCF input invert on



DCF input invert off

DCF77 inverting the input pin

- AU: input is automatically inverted or not (default).
AU is activated by pressing the + button.
- ON: Input inverts
- OFF: no input inverted *ON and OFF is activated and toggled by the - button.*
- Conrad DCF module = for PIN3 ON, PIN4 OFF
- ELV DCF module = ON
- Pollin DCF module (3.3 V) = OFF

No guarantee for correctness of the information and changes of the manufacturer.

If the receive LED is off every second, the setting must be inverted.

Power save pin invert

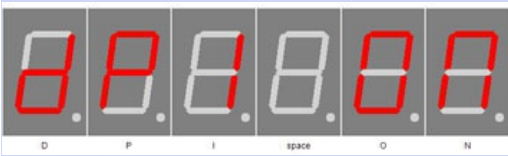

DCF powersave invert on



DCF powersave invert off

Inverts DCF77 power On / Off output

- ON: Power ON / OFF output is inverted (module ON at GND)
- OFF: power on / off output is not inverted. (module ON at VCC)
- Conrad DCF module = No power on / off input pin available
- ELV DCF module = No power on / off input pin available
- Pollin DCF module (3.3 V) = ON

No guarantee for correctness of the information and changes of the manufacturer.

Read the instructions of the receiver module for the power on / off pin of the DCF module to set this setting correctly. Many modules do not have this pin, then this setting can be ignored.

DCF sensitivity



DCF sensitivity

Sets the DCF Sensitivity. 1 has a very low tolerance and 6 has the highest tolerance for reception. The Sensitivity should be set as small as possible to avoid incorrect receiving. The number can be 1-6

DCF exit



DCF Exit

With + you exit the sub-menu DCF

Clock Settings

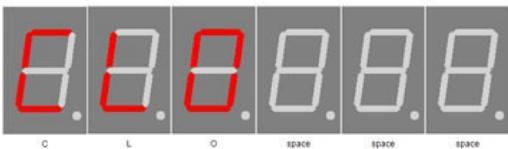

clock

With + you enter the sub-menu clock.

Set hour



change time

Set the hour.
The number can be 0-23.

Set minute



change time

Set the minute.
The number can be 0-59.

Set year

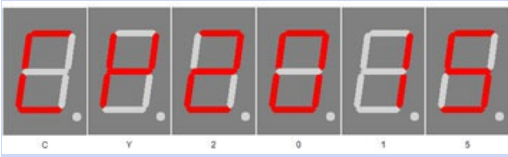

change year

Sets the year.
The number can be 2000-2099.

Set month



change month

Sets the month.
The number can be 1-12.

Set day

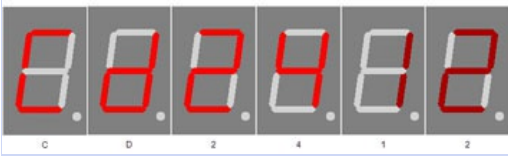

change day

Set the day, limit by month.
The number can be 1- 28, 29, 30, 31.

Day of week



Monday - Montag



Tuesday - Dienstag



Wednesday - Mittwoch



Thursday - Donnerstag



Friday - Freitag



Saturday - Samstag



Displays the day of the week from the set date.

Set time

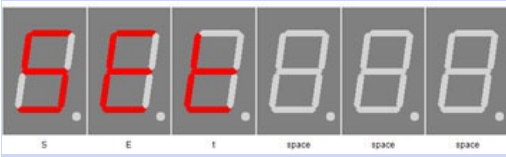

Set settings

Sets the time, while looking for DCF time, otherwise the time will be provided directly.

Calibrate quartz



Calibrate quartz +10



Calibrate quartz -10

With this setting the quartz can be calibrated, a positive value increases the period time and a negative value reduces it. The period should also be set as precisely as possible to 1ms or 1kHz (for frequency measurement). The measurement must be carried out on pin TB. Further information can be found in the chapter [Quartz properties - Accuracy of the time](#).

Exit clock settings

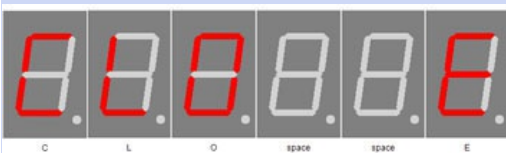

Clock end

With + you exit the sub-menu clock. Until here the clock, without DCF synchronization, will be taken and used until the next scheduled synchronization.

Info section

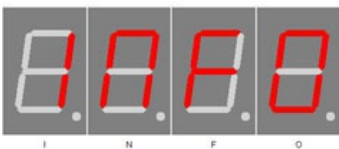

This indicates the start the information area

IC number

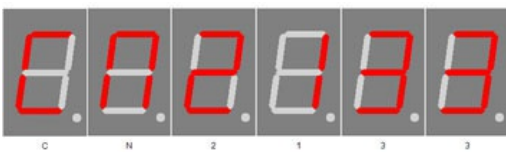

Chip number

IC / device type

Firmware version



Firmware version

Firmware version

Example, it might be something else at this point.

Menu end

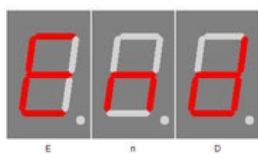

End

End of the menu, hide automatically after 2 seconds.

Attachment

Bootloader handling

Start the IC/module/device in bootloader mode

1. Switch off the IC/module/device.
2. Connect the UART adapter (USB → 3.3 volts or 5 volts UART or RS232 → 3.3 volts or 5 volts UART).
"DCF in" → UART adapter TXD and "DCF ps" → UART adapter RXD.
3. Press the button S1, power up the IC/module/device with voltage and do not release this button until you hear a short BEEP. The display is off.
4. Now you can connect to the firmware upload tool.



Wrong UART level

If an incorrect voltage level (for example directly RS232, ± 12 Volt) is used, the UART adapter or the IC/module/device can be damaged or destroyed. In the worst case, overheating and fire may occur!

NOTICE

Defect firmware

Defect firmware can be detected as follows: Every second a short BEEP.

Use the Firmware Upload Tool to upload an update

1. Download the latest upload tool from www.stefpro.biz: [SP Firmware UP](#)
2. Start the tool
3. Select the COM port.
4. Press the "Load" button and select a firmware which you have previously downloaded from SP Firmware UP
5. Now press the "Connect" button, the data from the IC / Module / device will be read and the compatibility of the new firmware with the IC / module / device will be checked
6. If an upload is possible, you can now press the "Upload Firmware" button. The upload starts and should not be interrupted.

NOTICE

Firmware upload interruption

If the firmware upload is interrupted or uploaded an inappropriate firmware, so there is a broken firmware, the IC can be operated only in bootloader mode.

7 segment characters

The symbolism of each character:

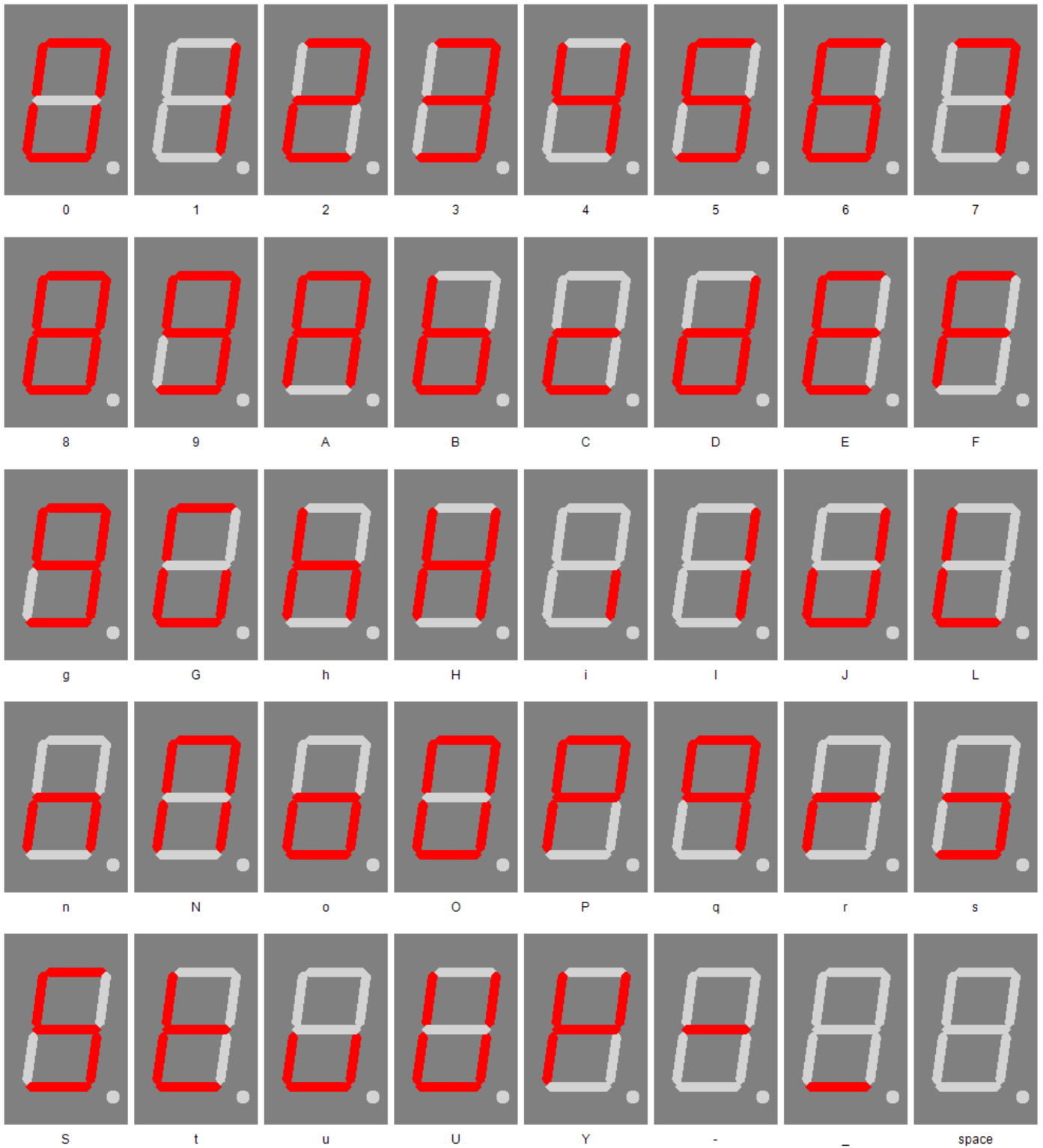

Change log

Safety

20.03.2017 - 1.0.3 - ADD
Add ESD note

DCF module properties

21.11.2016 - 1.0.1 - ADD

Add list of tested modules

20.03.2017 - 1.0.3 - ADD

Update list of tested modules, add standard pin assingment

Power supply properties

21.12.2019 - 1.0.5 - ADD

Add SNT description

Temperature sensor

22.03.2021 - 2.0.1 - ADD

Add add temperatur sensor and calibration description

Set day

23.04.2017 - 1.0.4 - ERROR

Bugfix wrong title, this sets the day not the month.

Liability, warranty and copyright notice

Definitions

- "Device": A product that can be operated by simple connection via a power supply to the home power net. The power adapter does not have to be included.

Liability

- Although the information contained in this document has been checked very carefully for accuracy and completeness, for errors and omissions can not be held liable. StefPro reserves the right to any time change any portion of the described hardware and software features.
- There is no liability for damages incurred directly by or in the application of the "module", as well as for damage caused by chemical or electrochemical effects of water or generally from abnormal environmental conditions.
- "Device" by StefPro should not be used in critical areas."

These include:

- medical devices for implanting or life obtained.
- Critical equipment for space, aerospace and traffic.
- Other important life components or systems, where an error is fatal.

Safety Notes

- Since the built device is operated with an electrical voltage, the valid VDE regulations are complied with.
- This device is not in the hands of children!
- The device complies with the requirements of protection class III.
- The "device" may NOT directly to line voltage (or voltage > maximum operating voltage) in any case! It can be fatal!
 - Whenever it is that safe operation is no longer possible, the device must be taken out of service and secured against inadvertent operation. This assumption is justified,
 - when the device has visible damage,
 - when the device has loose parts
 - when the device no longer works
 - after prolonged storage under unfavorable conditions (eg outdoors or in moist environments)

Watch for correct voltage and connection of the device voltage and / or connection mistakes are beyond our control. Thus we can not assume any liability for damages arising out of it.

Intended operation

- The used electrical parts and components are designed for a temperature between 0 °C ... +45 °C, so the device may only be operated and stored in this temperature range. During transport, the temperature may be between -10 °C ... + 50 °C.
- If condensation has formed during transport or storage, the modules must be acclimatized for approx. 2 hours before commissioning.
- It must not be operated in an increased dust, high humidity, explosion risk or aggressive chemical exposure.
- Ensure proper operation and connection. Operating and/or connection errors are outside our area. Unfortunately, we can not accept any liability for damages resulting of this.
- The improper operation of this module may result in damage of this module, personal injury or property damage.
- The safety instructions must be observed!
- The manufacturer is not responsible for all personal injury and property damage caused by improper operation.

Warranty

- StefPro only warrants the device and its firmware. The warranty is limited to the exchange of the device within the warranty period in case of obvious defects of the hardware, as well as faulty programming.
- Warranty does not extend the warranty period or starts a new period again.
- Additional or deviating claims are excluded, especially claims for damages arising out of the product for damage. This will not affect claims based on inalienable rules under the product liability law.

Copyright notice

The circuitry and firmware on the device from StefPro is protected by copyright. Unauthorized reproduction or distribution of Modules with this program or any portion of it. This is pursued both criminal and civil law, and may result in severe penalties and compensation for damages.

Status of the information 10.01.2018.

Disposal information

Do not dispose devices in household garbage!

This modules or devices comply with the EU directive on electronic and electrical equipment (WEEE regulation) and therefore may not be disposed of with household waste. Dispose of the device over your local collection center for electronic equipment!



WEEE-Reg.-Nr.:

DE 58929072 (StefPro UG (haftungsbeschränkt) & Co. KG)

DE 78089358 (StefPro Einzellunternehmen bis zum 01.01.2015)

Impress

StefPro™ UG (haftungsbeschränkt) & Co. KG **- Softwareentwicklung für Prozessoren**

Dipl. Ing. (FH) Stefan Nannen

Theilenmoorstr. 11

26345 Bockhorn – Germany

Phone: +49-4452-709175

Web:<http://www.stefpro.biz/>

E-mail: info@stefpro.biz