

SPO2233.01

Six digit dcf clock

with 4x20mm + 2x14mm red 7 segment LED displays
and temperature
and extended alarm function

Datasheet

Version: Firmware 1.82-148

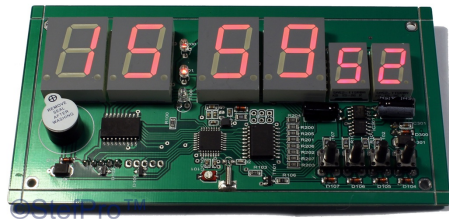

StefPro UG (haftungsbeschränkt) & Co. KG

Theilenmoorstr. 11
26345 Bockhorn, Germany

Phone: +49-4452-709175
Web: <https://www.stefpro.biz/>
E-mail: info@stefpro.biz

Data Sheet Version 2.0.1 - Valid from 22.03.2021.

Table of Contents

Table of Contents	2
Safety	4
Application and function description	5
Function description	5
Technical data	6
Construction description	6
Installation of the module (Dimensions)	6
Connectors	6
X-DC : DC Power input : Print plug 2 pole	7
X-DCF : DCF input, DCF PowerSave output: Print connector 5 pin	7
Signal description	8
V+	8
VCC	8
GND	8
DCF ps	8
DCF in	8
Properties of the components	9
DCF module properties	9
Tested modules	9
Our standard color coding for DCF signals	9
Connection of the DCF module using a fake module	9
Without Power On / Off or Power Save input	9
With Power On / Off or Power Save input	10
Power supply properties	11
Temperature sensor	11
Method of calibration with a temperature value	12
Procedure for calibration with an offset value	12
Installation the DCF clock	13
Synchronize with active display	13
Synchronize with deactivated display	13
Button description	15
Overview of buttons	15
Button functions	15
General key functions	15
Menu	15
Normal	16
Display mode of clock	16
Show Temperature	17
Alarm	17
Alarm day selection	18
Alarm enable	18
Alarm time hour	18
Alarm time minute	19
Alarm snooze time	19
Alarm sound wait time	19
Alarm maximum time	19
Alarm exit	19
Brightness	19
Brightness menu	20
Brightness max	20
Brightness min	20
Brightness automatically	20
Brightness speed	20
Brightness factor	20
Brightness offset	21
Activate standby	21
StandBy start hour	21
StandBy end hour	21
StandBy Brightness	21
Exit brightness settings	22
DCF	22
DCF active	22
Receiving brightness	22
Hour of synchronization	22

Receive state display	22
DCF input pull up	23
DCF input invert	23
Power save pin invert	23
DCF sensitivity	23
DCF exit	24
Clock Settings	24
Set hour	24
Set minute	24
Set year	24
Set month	24
Set day	25
Day of week	25
Set time	25
Calibrate quartz	26
Exit clock settings	26
Info section	26
IC number	26
Firmware version	26
Menu end	26
Attachment	27
Bootloader handling	27
Start the IC/module/device in bootloader mode	27
Use the Firmware Upload Tool to upload an update	27
7 segment characters	28
Change log	28
Safety	28
DCF module properties	28
Power supply properties	29
Temperature sensor	29
Set day	29
Liability, warranty and copyright notice	30
Definitions	30
Liability	30
Safety Notes	30
Intended operation	30
Warranty	30
Copyrightnotice	31
Disposal information	32
Impress	32

Safety

Follow the manual



The module is only safe in operation if all instructions are read in this datasheet.

General understanding of safety

By the module there are no hazard under normal use.

Intended Use

The module is designed for driving small to middle displays.

The power should come from a safe transformer (also protected transformer) or a corresponding low voltage power supply for the circuit.









Never use a higher voltage or direct mains voltage!

Concealed Hazards



DANGER

following hazards may arise in case of wrong construction of the circuit and wrong handling of module:

-  With the direct connection to mains, it's a dangerous voltage on the module and other components, use a safety transformer!
-  Reverse polarity and overloading the module may cause in smoke. This smoke possibly contains toxic substances which must not be inhaled! Ventilate the room.
-   Reverse polarity or overload of the module can cause a hot surface on the IC or other component in the circuit.
 - There is a risk of burning when touching.
 - And flammable materials, for example Paper, can come in fire.
-  Spalling of parts on reverse polarity or overloading of the module.
-  Wear during the initial commissioning eye protection.
-  The pins of the components can be pointed and sharp even after installation! Therefore, this may cause in sores in case of incorrect handling.
-  If the buzzer emits more than 90 dB, it may cause hearing loss over a long period of time. The circuit board is intended for installation in a housing, thereby lowering the level of the buzzer used.
-  Use always passing a ESD bracelet to avoid electric charges! The module can be damaged if handling without an earthing tape and housing!

Modifications of the example circuit

The successfully built device may be damaged. Therefore check as appropriate all housing part and lines for damage. This applies in particular to parts of the directly (for example power cord and power supply) or indirectly come into contact with mains voltage.

Application and function description

Function description

This IC can analyze the DCF77 signal, which is received by a receiver and demodulated. The received time and date can output directly to a 7-segment displays. The clock synchronizes itself automatically once a day. The hour of the synchronization can be set in the menu.

The time is displayed according to DIN 5008, which means a leading 0 at the hour. 8 a.m. looks like 08:00:00 and 8 p.m. 20:00:00

Due to the 6-digit display, the date is not shown according to DIN 5008. The 24 December 2020 looks on the display like 24.12.20.

The DCF77 signal is a low frequency radio signal which transferred the time and date. It will be sent in Frankfurt am Main, derived of the local atomic clock and sent with the carrier frequency of 77.5 kHz. Therefore, these watches are also known as radio clock.

The input for the DCF77 antenna can now automatically detect whether a pullup resistor is required and whether the input has to be inverted.

With this IC an advanced alarm clock function is implemented. In this each day can be set individually.

This IC also has an adjustable brightness control for the display, thereby the display is easy to read during the day and at night it does not light out the entire room.

With this IC the **temperature** will be displayed alternately with the time and or date.

This IC has a bootloader, which allows you to update the IC firmware. This means that you will always remain at the current state of the Firmware for the IC, without further costs.

Technical data

- Operating voltage: 9 - 12 volts DC
- Current: 200mA
- Power: approximately 1.8 W (at 9 volts)
- Volume level of the buzzer: approx. 85 to 90 DB
- Accuracy of the timer: better uncalibrated 99.999.9 %; calibrated better 99.99999.999 %
- Temperature accuracy:
 - Worst inaccuracy: ± 2.5 °C
 - Typical: ± 1 °C
 - Calibrated: $< \pm 1$ °C

The values apply when using the LM35, when calibrated, the value can also be reached for other sensors.

Construction description

Installation of the module (Dimensions)

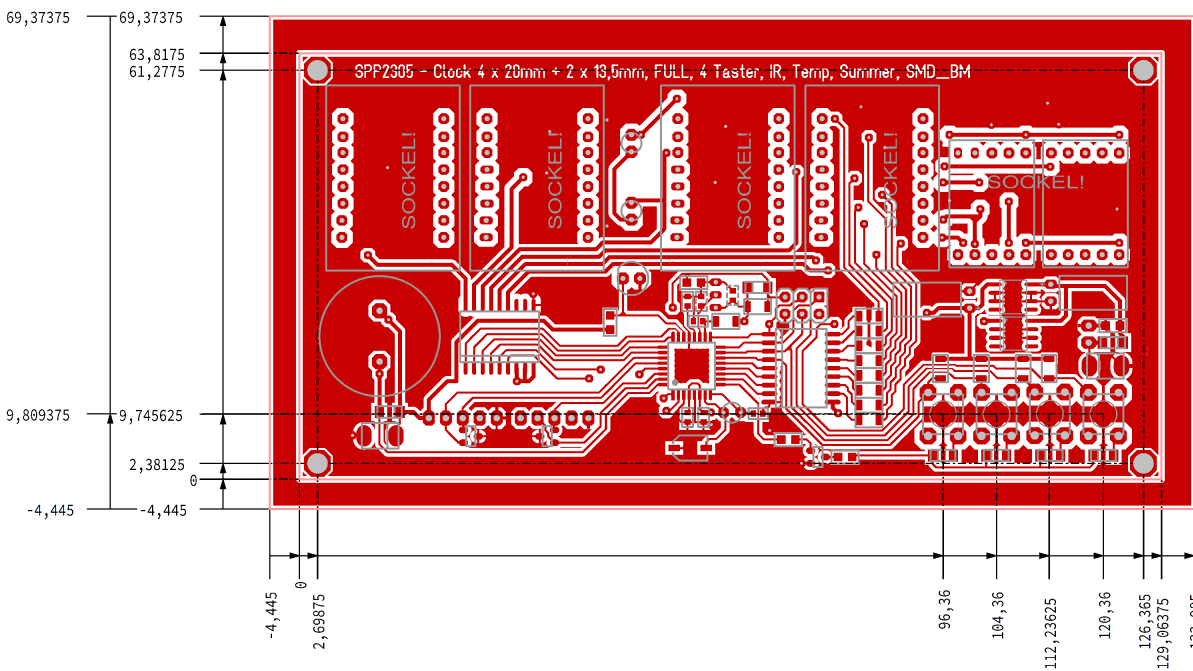

Figure 1: Installation (Dimensions) description for module SPP2305.1

Secure the module securely in a housing with an M3 screw.

Connectors

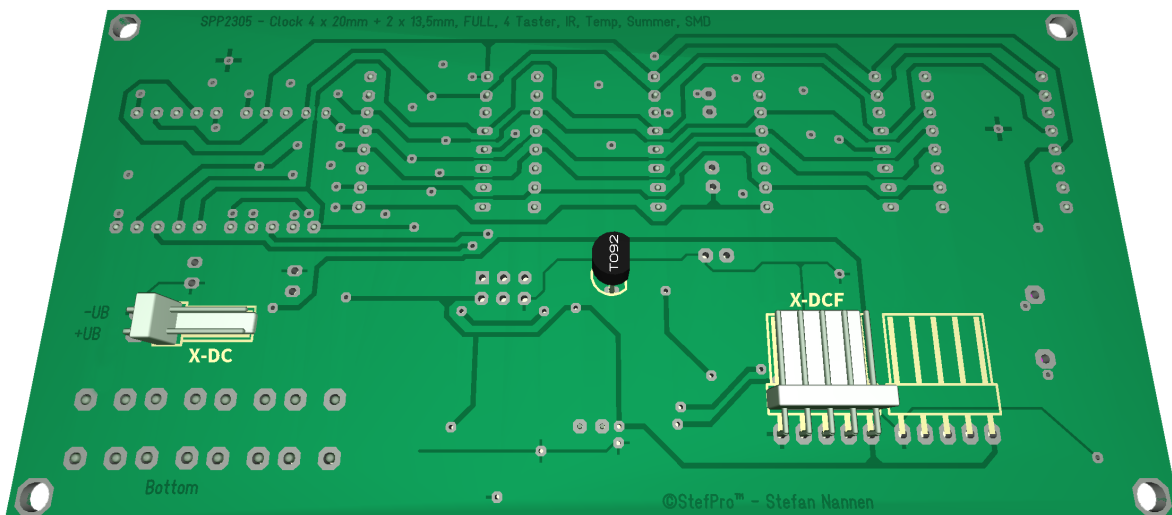

Figure 1: Connector description for module SPP2305.1

Insert the appropriate plugs with little effort.

DANGER

Make sure that you have connected all signals correctly. There is no overload and polarity protection!

X-DC : DC Power input : Print plug 2 pole

Pin	Name	Direction	Function	Maximum
1	GND	Power		
2	V+	Power	Power supply input of the module	9 - 12 volts DC, 200mA

X-DCF : DCF input, DCF PowerSave output: Print connector 5 pin

Pin	Name	Direction	Function	Maximum
1	GND	Power		
2	N.C.		Do not connect	VCC
3	DCF in	Digital input	DCF signal input	VCC
4	DCF ps	Digital Output	DCF PowerSave output	VCC
5	VCC	Power		5 volts DC, 30mA

Never solder the DCF module directly onto the circuit board, even if the ELV module suggests it. Please connect this with some stranded wire to allow a certain distance to the display.

Please also note the information in the chapter "Properties of the components - DCF module properties".

Signal description

V+

Operating voltage

VCC

Operating voltage for external modules

GND

Ground

DCF ps



DCF Modules Enable pin, this pin enables the DCF modules when needed. Whether the pin is LOW or HIGH active can be set in the menu.

DCF in

Input for the DCF77 antenna. Inverting can be adjusted automatically or manually. Pull up resistor can be switched on in the menu.

Properties of the components

DCF module properties

- The module has to be able to work with an operating voltage of 5V (some modules have an operating voltage range of 1.2 to 15 volts, these are also usable)
- The output has to be able to drive a CMOS input with a input impedance of 10kΩ
- For DCF modules with open collector (open collector) or open drain output the input detected automatically by default whether a pull-up resistor is required. In menu a pull-up resistor can be connected or disconnected permanently.
- Polarity of the output:
 - The output has to be non inverting, the high  state has to be 100ms or 200ms
 - The output has to be inverting, the low  state has to be 100ms or 200ms
 - The receiving LED should at good reception signal flash every second for 100 ms and 200 ms. Does the receiving LED goes off every second for 100 ms and 200 ms, then the polarity is wrong. Unfortunately, you then connected a wrong module, this can't be analyzed with the microcontroller.
 - Whether the output is non inverting or inverting, is detected automatically by default or can be set in the menu.
 - The receiving LED should at good reception signal flash every second for 100 ms and 200 ms. Does the receiving LED goes off every second for 100 ms and 200 ms, then the polarity is wrong. To correct this, you has to be invert the setting for the inverting DCF input pin in the menu. (Instead of on → off → on or off)
- The DCF module can have a power on / off pin. Then the DCF module is automatically switched off when the DCF signals from the microcontroller are not analyzed. In the menu can be set if the DCF module is with low or high on.

Tested modules

Module	GND	VCC	DCF input	PowerSave output	Comment
Conrad DCF Modul	1 (GND)	2 (Betriebs...)	3 (DCF Ausgang)	-	
ELV DCF Modul	3 (Masse)	1 (+ UB)	2 (Signal-Ausgang)	-	
Pollin DCF Modul	GND	VCC	DATA	PON	Caution An additional circuit is required for an operating voltage of more than 3.3V!

Our standard color coding for DCF signals

- GND: black
- VCC: rot
- DCF input: green
- PowerSave output: white (is not supported by each DCF receive module)

You can usually also supply the DCF receiver via the PowerSave output. But in this case you must ensure that this output is not inverted in the menu and that the pin must not be permanently loaded with more than 20 mA.

Connect the DCF module with approx. 10 cm wire, it is best to select the colors as in the table above, so that this can be mounted at some distance from the display.

WARNING

Please check the pin assignments! It is not in our hands whether the manufacturers of the DCF receive modules change the pin assignments at a later date.

Connection of the DCF module using a fake module

Here you will find some examples for the wiring of the DCF modules, as already mentioned, some strands are intended for wiring.

Without Power On / Off or Power Save input

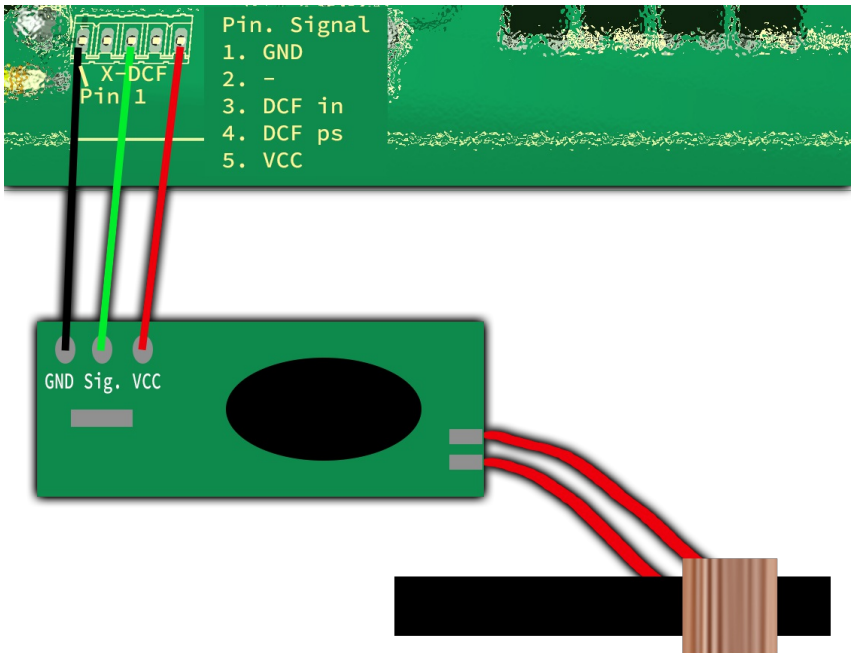

Figure 2: DCF connection to VCC

In the figure above you can see the classic wiring of the 5-pin pin strip and the DCF receiver module. Here the receiving module is permanently supplied with 5 volts or VCC and therefore also permanently supplies a signal.

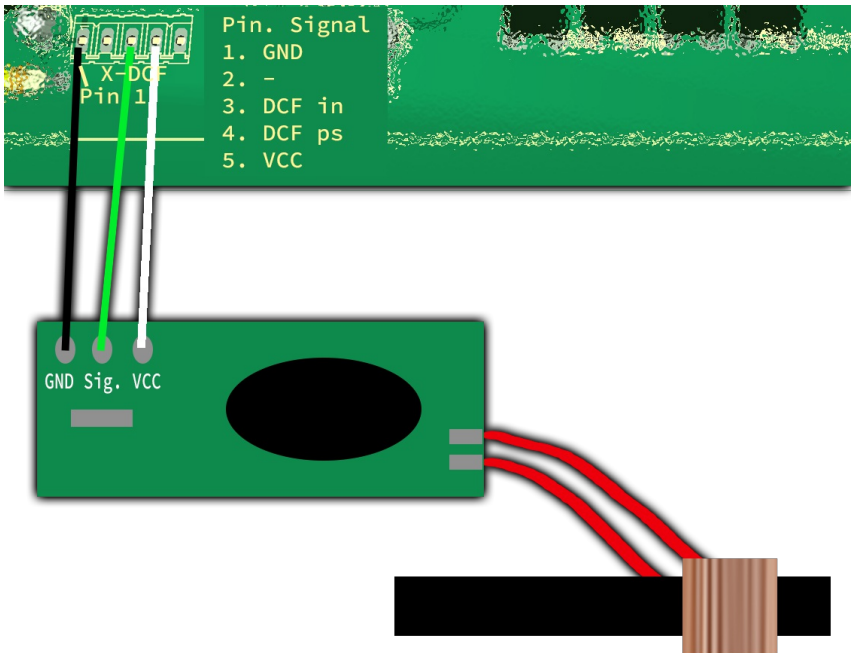

Figure 3: DCF connection with PowerSave

In this figure above you can see a wiring with the PowerSave signal as VCC for the DCF receiving module. Here the receiving module is only supplied with voltage while the analysis is being carried out. When using this, make sure that the setting in the DCF menu does not invert the PowerSave output (see "Power save pin invert")!

With Power On / Off or Power Save input

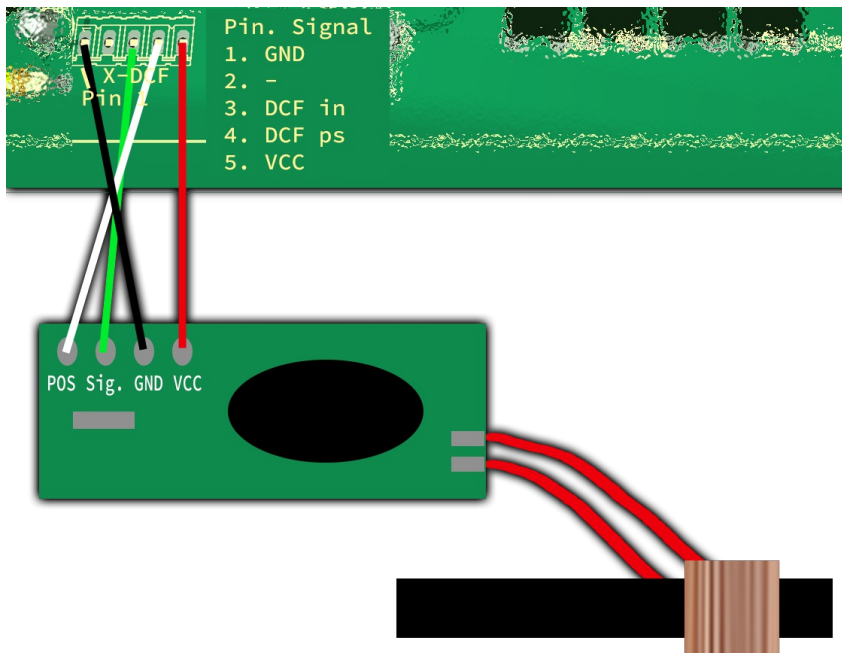

Figure 4: DCF connection with VCC and PowerSave

Here you can see the wiring with VCC and the PowerSave signal. Here the receiving module is only switched on while the analysis is being performed. A supply of voltage is permanent.

Power supply properties

Since the clock is usually to be operated on a 230 volt power supply, a power supply unit is required. This can be a normal transformer power supply or a switching power supply.

Transformer power supply:

- Pro:
 - Cheap
 - Little interference for DCF reception
- Contra:
 - Heavy
 - Depending on the power is it big
 - Poor efficiency
 - Even if the circuit requires little power, some power may be needed
 - Higher electricity costs

Switching Power Supply:

- Pro:
 - Light
 - Small
 - Good efficiency is possible
 - Standby possible with very low power requirements
 - Lower electricity costs than with the transformer power supply
- Contra:
 - Larger interference for DCF reception
 - Usually a little more expensive

Switching power supplies should be preferred, unfortunately they have the disadvantage that many can interfere with the DCF reception and the DCF clock is not synchronized. Switching power supplies with a PE feedthrough (PE is connected to ground) often have better interference behavior, but this cannot be generalized. The switching power supplies offered in our shop have been tested and only minimally interfere with DCF reception.

WARNING

Use only a power supply unit with electrical isolation!

Temperature sensor

The temperature sensor is used to display the temperature and it must be an analog sensor with 10mV / 1°C. This is to be connected to the temperature sensor input (TempSen).

Installation the DCF clock

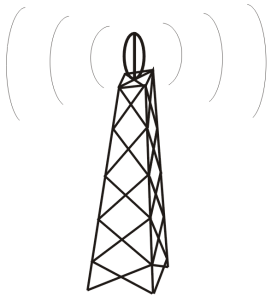

Sender in Frankfurt



DCF77-Antenne

Figure 5: Align the DCF antenna

The external antenna receives the DCF77 signal and should be directed to Frankfurt, as shown in Figure 5. The antenna should be placed at least 1 meter away from a monitor, computer or other disturbing electronic devices .



During installation, the receiving LED can be used as an orientation to the quality of reception. The LED should flash at intervals of one second. If the antenna is properly aligned and the signal is strong enough, the display changes of „no signal,, (No impeccable DCF77 signal) in „SEArCH,, (search for the 59th second). Was the 59th second found so will the display shows „rEAd60,, (read the DCF time) henceforth. It still takes 60 seconds to display the correct time. If the clock is not synchronized to the DCF time, the receiver LED flashes DCF work cycle (power reserve is in operation), if the LED is enabled in the menu. Is the display not changed to „SEArCH,, the antenna is probably disturbed by a device or the antenna is too close to the display. Because the DCF antenna is so sensitive that it can disturb by the display in the near field, there is the possibility to reduce the brightness of the display during the synchronization, or to deactivate the display. This problem have all other DCF clocks with multiplexed LEDs displays also. By a darker display the DCF antenna can be mounted significantly closer to the display.

Synchronize with active display

This mode is active when in menu under "receive brightness" the brightness is set > 0. Appearance of the text on the screen:



Synchronize with deactivated display

This mode is active when in menu under "receive brightness" the brightness is set to 0. When synchronizing with disabled display, only one decimal point for orientation appears.

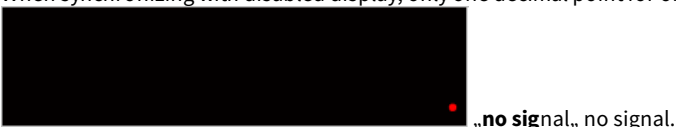



„**SEArCH**„ Search the fifty-ninth second.



„**rEAdXX**„ read the dcf time.

Button description

Overview of buttons

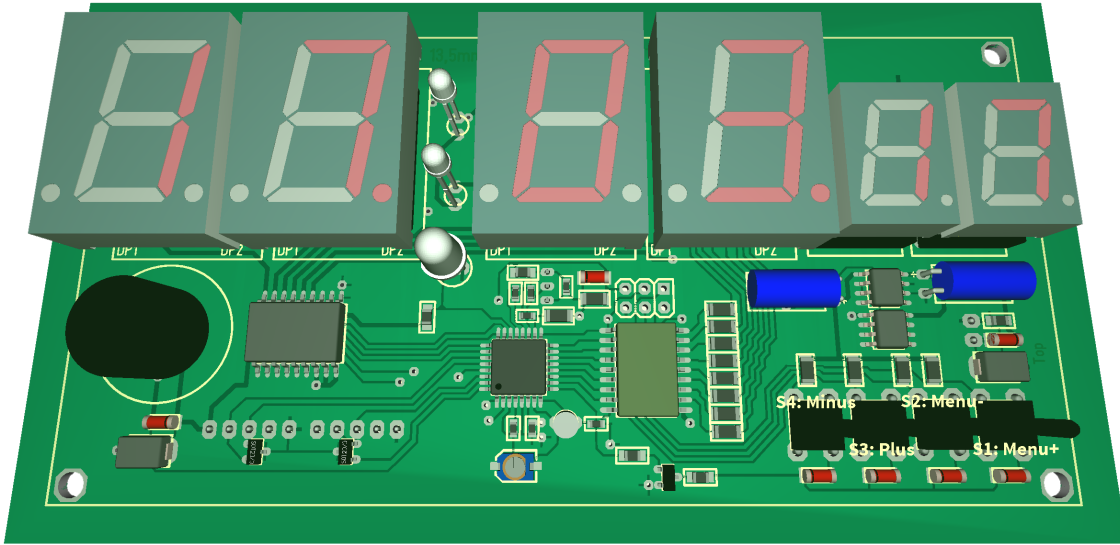

Button functions

- Menu+ Opens the menu, next setting
- Menu- Opens the menu, previous setting
- Plus or + Function key, usually +, On or jump into and exit a submenu
- Minus or - Function key, in general - or off

To open the menu you have to press one the menu buttons. Use the menu+ button to navigate forward and the menu- button to navigate backward.

General key functions

- A submenu is always opened with the "Plus" or "+" key and with menu display "... E" it can be exited again with "Plus" or "+".
- For numerical properties, the number is increased with the "Plus" or "+" key and decreased with the "Minus" or "-" key.
- If it is an On / Off property, then "Plus" or "+" sets On and "Minus" or "-" sets Off.
- With lists, the value is changed according to the order with the "Plus" or "+" button, with "Minus" or "-" this happens in the opposite way.
- In special cases, this is described in detail next to the images.

Menu

Level 1	Level 2
Normal ↓	
Display mode of clock ↓	
Show Temperature ↓	
Alarm ↓	Alarm day selection → Alarm enable → Alarm time hour → Alarm time minute → Alarm snooze time → Alarm sound wait time → Alarm maximum time → Alarm exit ☺
Brightness ↓	Brightness menu → Brightness max → Brightness min → Brightness automatically → Brightness speed → Brightness factor → Brightness offset → Activate standby → StandBy start hour → StandBy end hour → StandBy Brightness → Exit brightness settings ☺
DCF ↓	DCF active → Receiving brightness → Hour of synchronization → Receive state display → DCF input pull up → DCF input invert → Power save pin invert → DCF sensitivity → DCF exit ☺
Clock Settings ↓	Set hour → Set minute → Set year → Set month → Set day → Day of week → Set time → Calibrate quartz → Exit clock settings ☺

Information
 IC number
 Firmware
 version

Level 2

⏴: Next step in main menu.

➡: Next step in sub menu.

↺: The submenu starts again.

Normal

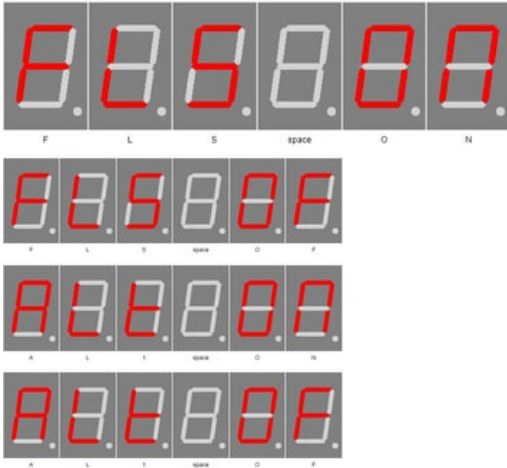

Normal mode, outside of the menu.

Here the plus (+) button has the function of the alarm temporary switch on or off.

The minus (-) key switches the display back to 100% (flashlight, automatic brightness control is switched off) or to normal brightness.

Display mode of clock

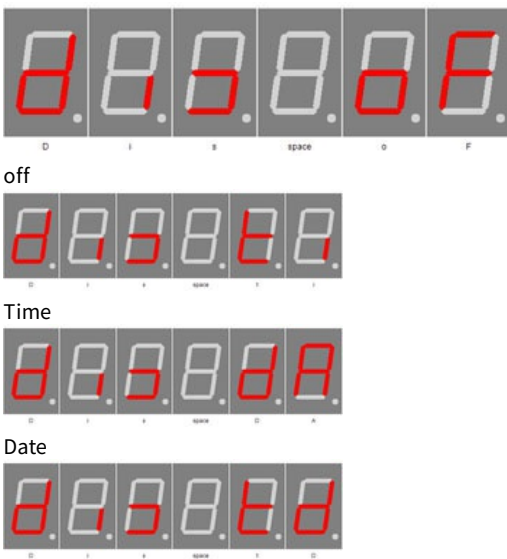

off

Time

Date

Time & Date

Use plus (+) and minus (-) to set the mode how to display time and date.

- OF: Does not display the time / date. When the temperature display is active, the temperature is displayed continuously. If no temperature display is possible or active, dashes (-) are shown in the display.
- ti: Shows only the time.
- dA: Shows only date.
- td: Shows time and date alternately.

NOTICE
 If the temperature display is active, always alternate with it.

Show Temperature

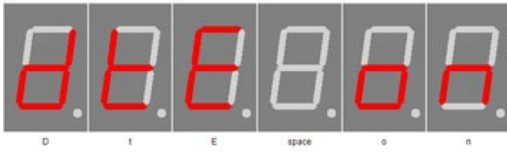

Display temperature on



Display temperature off



Temperature calibration

Enables the temperature display. Plus (+) enables the temperature display and minus (-) disables it.

Long press plus (+) activates the calibration via temperature input, long press - activates the calibration via offset value. You can find more information in the chapter "Temperature sensor" - "Method of calibration ...".

Alarm

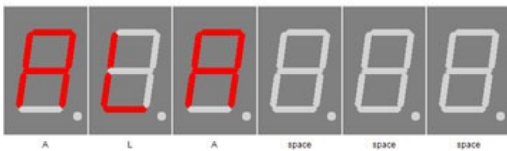

ALARM

With plus (+) you enter the sub-menu Alarm.

Alarm day selection

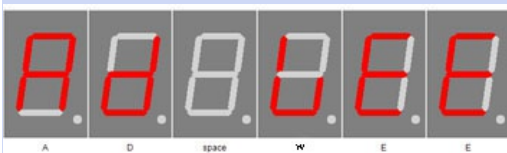

Use plus (+) and minus (-) to select the day or which group is to be edited. There are the group Week (WEE) and weekend (wnd). Saturday and Sunday are in the group weekend, all other days are in the group week. Through these groups, it is possible to set the alarm for several days at once. If the alarm is active for the week, so the weekdays can no longer be adjusted individually and inheriting the groups setting. A decimal point indicates whether the alarm on the day or group is active.

Alarm enable

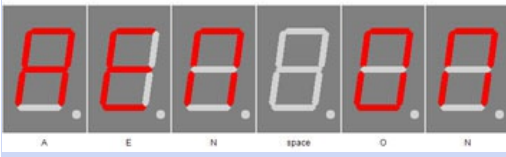

ALARM ON

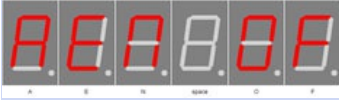

ALARM OFF

Enables the alarm. Plus (+) sets the alarm to "AEN ON" and minus (-) sets it to "AEN OF".

Alarm time hour

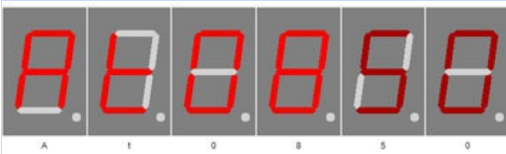

Alarm hour

Use plus (+) and minus (-) to set the hour for alarm. The number can be 0-23

Alarm time minute

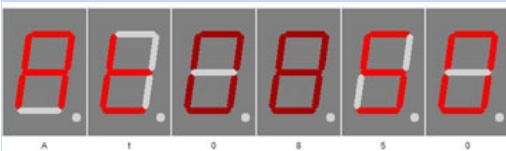

Alarm minute

Use plus (+) and minus (-) to set the minutes for alarm. The number can be 0-59

Alarm snooze time



Alarm snooze time

Use plus (+) and minus (-) to set the minutes for the snooze function. The number can be 1-30

NOTICE

If "alarm maximum time" is shorter than alarm snooze time, the snooze function is disabled!

The snooze function can be activated in alarm/wake-up mode with plus (+) and minus (-) and the alarm can be stopped with the menu buttons.

Alarm sound wait time



Alarm sound delay

Use the plus (+) and minus (-) buttons to set the maximum alarm duration in minutes. The number can be 0 - 10.

NOTICE

If "Alarm sound delay" greater selected as maximum alarm time, then the display is only set to 100% brightness! No buzzer alarm!

Alarm maximum time

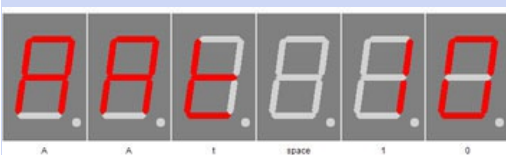

Alarm after time

Use plus (+) and minus (-) to set the maximum time in minutes for the alarm. The number can be 2-60.

Alarm exit

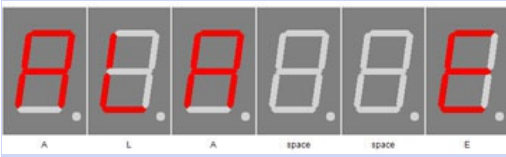

Alarm exit

With Plus (+) you exit the sub-menu alarm.

Brightness

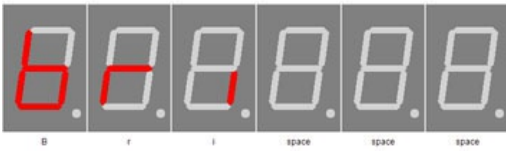

Brightness

With plus (+) you enter the sub-menu brightness.

Brightness menu



Brightness

Sets the brightness of the menu. The number can be between 10 and 25, with 10 being the darkest menu and 25 the lightest.

Brightness max



Brightness high

In this menu item, the maximum brightness plus (+) and minus (-) of the display can be adjusted.
This is also used when auto brightness is disabled.
The number can be between 0 and 25, with 0 being the darkest and 25 the lightest.

Brightness min



Brightness low

In this menu item, the minimum display brightness can be adjusted with plus (+) and minus (-).
The number can be between 0 and 25, with 0 being the darkest and 25 the lightest.

Brightness automatically



Brightness automatically on



Brightness automatically off

This allows to turn on with plus (+) and off with minus (-) the auto brightness.

Brightness speed



Brightness speed

Use plus (+) and minus (-) to set the speed of auto brightness.

The number can be between 0 and 20 and delays the brightness calculation by approx. 100 ms. With the setting 20, the brightness is therefore recalculated every 2 seconds. The maximum value may differ depending on the firmware.

Brightness factor



Brightness factor

Use plus (+) and minus (-) to set the calculation factor for auto brightness.

The number can be 1-99. There is no unit for this, as it cannot be defined due to component tolerances.

Brightness offset



Brightness offset

Use plus (+) and minus (-) to set the calculation offset for auto brightness.

The number can be between -99 and 99. There is no unit for this, as it cannot be defined due to component tolerances.



Brightness offset -99



Brightness offset +99

Activate standby



StandBy (Powersave) Enable On

With plus (+) activate and minus (-) deactivate the standby mode, in this case the display is switched off or darkened. This depends on the "standby brightness". The clock and alarm function are still available, the time, date or temperature are simply not displayed.

Through the flashlight function can this interrupted.



StandBy (Powersave) Enable Off

StandBy start hour



StandBy (Powersave) Start Hour

The standby operation starts from this hour. Only full hour can be set by plus (+) and minus (-).

The range is from 0 (midnight) to 23 (11pm).

StandBy end hour



StandBy (Powersave) Finish Hour - Endstunde

From this hour on, standby operation ends. Only full hour can be set plus (+) and minus (-).

The range is from 0 (midnight) to 23 (11pm).

StandBy Brightness



StandBy (Powersave) Brightness level 1

Use plus (+) and minus (-) to adjust the brightness of the display in standby mode, 0 means off.

The range is 0 to 90, but 90 corresponds to 9 of the other brightness settings in this menu.

Exit brightness settings

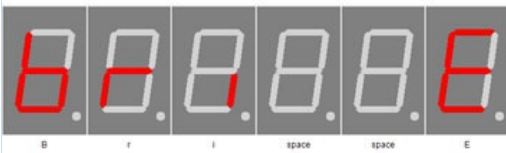

With plus (+) you exit the sub-menu brightness.

DCF

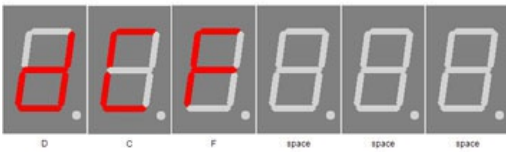

DCF

With Plus (+) you enter the sub-menu DCF.

DCF active

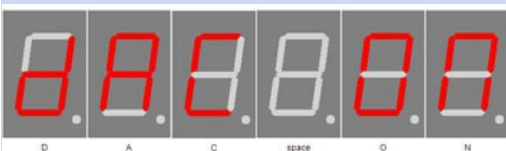

DCF active on



DCF active off

Use plus (+) and minus (-) to set whether or not DCF reception is active. If the DCF reception is deactivated, the clock only works with the built-in quartz clock. Note that in this case the time base must be set as well as possible.

Receiving brightness

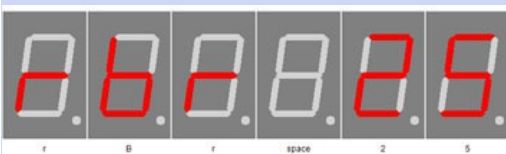

Receiving brightness

Use plus (+) and minus (-) to set the brightness during the DCF receiving. If 0, the display is turned off and the status of the synchronization is shown by decimal points. The number can be 0-25.

Hour of synchronization

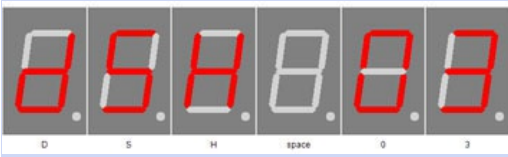

DCF synchronize hour



DCF synchronize hour disabled

Use plus (+) and minus (-) to set the hour in which the DCF clock will synchronize. In this hour, the DCF signal will be analyzed until a synchronization has occurred or the hour changes.

The number can be 0-23.

If the display shows "--" instead of a number, the synchronization hour has been deactivated and the dcf receiver is constantly trying to synchronize. In this case, the receipt display can also be displayed permanently.

Receive state display



DCF status decimal point display

Use plus (+) and minus (-) to set the mode for the receive LED, which shows the received signal. The number can be 0-2.

- 0: Only until the clock has been synchronized.
- 1: Shows the received signal when the clock is not synchronized with the DCF77 signal.
- 2: During the synchronization phase, the receive signal is always on the receive LED regardless of the DCF77 synchronization flag.

Only while the clock is trying to receive the DCF signal, see "Hour of synchronization".

DCF input pull up



DCF input pull up auto



DCF input pull up on



DCF input pull up off

DCF77 input pin with pullup

- AU: Pull Up is automatically (default).
AU is activated by pressing the plus (+) button.
- ON: Enables the pull-up resistor
- OFF: Disables the pull-up resistor
ON and OFF is activated and toggled by the minus (-) button.
- Conrad DCF module = ON
- ELV DCF module = ON
- Pollin DCF module (3.3 V) = OFF

No guarantee for correctness of the information and changes of the manufacturer.

DCF input invert

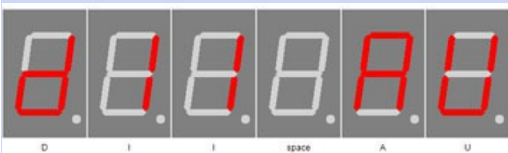

DCF input invert auto



DCF input invert on



DCF input invert off

DCF77 inverting the input pin

- AU: input is automatically inverted or not (default).
AU is activated by pressing the plus (+) button.
- ON: Input inverts
- OFF: no input inverted
ON and OFF is activated and toggled by the minus (-) button.
- Conrad DCF module = for PIN3 ON, PIN4 OFF
- ELV DCF module = ON
- Pollin DCF module (3.3 V) = OFF

No guarantee for correctness of the information and changes of the manufacturer.

If the receive LED is off every second, the setting must be inverted.

Power save pin invert

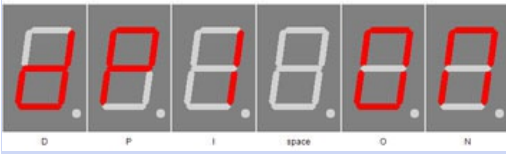

DCF powersave invert on

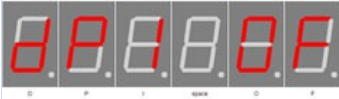

DCF powersave invert off

Inverts DCF77 power On / Off output, plus (+) enables inversion and minus (-) disables it:

- ON: Power ON / OFF output is inverted (module ON at GND)
- OFF: power on / off output is not inverted. (module ON at VCC)
- Conrad DCF module = No power on / off input pin available
- ELV DCF module = No power on / off input pin available
- Pollin DCF module (3.3 V) = ON

No guarantee for correctness of the information and changes of the manufacturer.

Read the instructions of the receiver module for the power on / off pin of the DCF module to set this setting correctly. Many modules do not have this pin, then this setting can be ignored.

DCF sensitivity

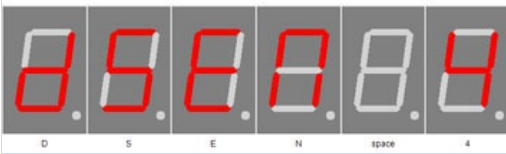

DCF sensitivity

Use plus (+) and minus (-) to set the DCF Sensitivity. 1 has a very low tolerance and 6 has the highest tolerance for reception. The Sensitivity should be set as small as possible to avoid incorrect receiving. The number can be 1-6. Tolerance means the deviation from the high and low of the time signal, i.e. 100 or 200 ms of the DCF signal.

DCF exit

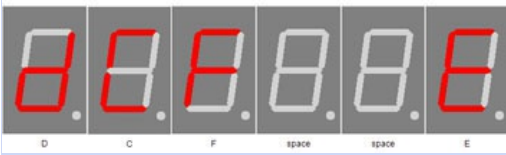

DCF Exit

With plus (+) you exit the sub-menu DCF

Clock Settings

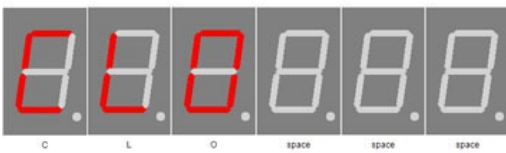

clock

With plus (+) you enter the sub-menu clock.

Set hour



change time

Use plus (+) and minus (-) to set the hour. The number can be 0-23.

Set minute



change time

Use plus (+) and minus (-) to set the minute. The number can be 0-59.

Set year

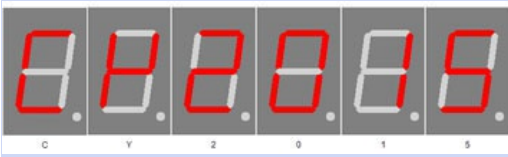

change year

Use plus (+) and minus (-) to set the year.
The number can be 2000-2099.

Set month



change month

Use plus (+) and minus (-) to set the month.
The number can be 1-12.

Set day

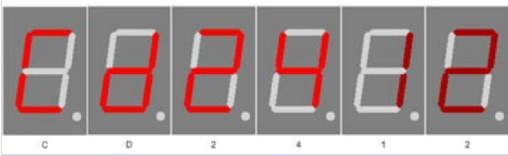

change day

Use plus (+) and minus (-) to set the day, limit by month.
The number can be 1- 28, 29, 30, 31.

Day of week



Monday - Montag



Tuesday - Dienstag



Wednesday - Mittwoch



Thursday - Donnerstag



Friday - Freitag



Saturday - Samstag



Displays the day of the week from the set date.

Set time

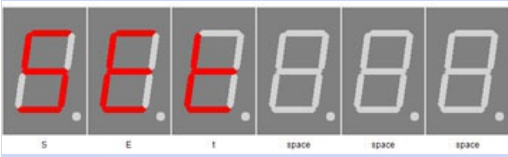

Set settings

Plus (+) sets the time, while looking for DCF time, otherwise the time will be provided directly.

Calibrate quartz



Calibrate quartz +10



Calibrate quartz -10

With plus (+) and minus (-) the quartz can be calibrated, a positive value increases the period time and a negative value reduces it. The period should also be set as precisely as possible to 1ms or 1kHz (for frequency measurement). The measurement must be carried out on pin TB. Further information can be found in the chapter [Quartz properties - Accuracy of the time](#).

Exit clock settings



Clock end

With plus (+) you exit the sub-menu clock. Until here the clock, without DCF synchronization, will be taken and used until the next scheduled synchronization.

Info section

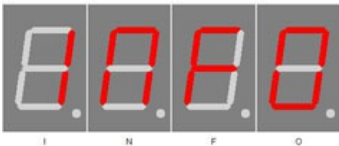

This indicates the start the information area

IC number

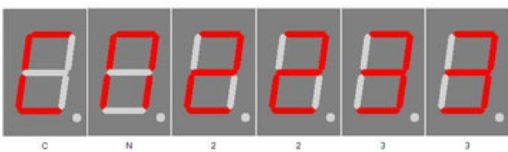

Chip number

IC / device type

Firmware version



Firmware version

Firmware version

Example, it might be something else at this point.

Menu end

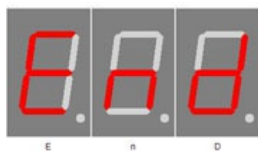

End

End of the menu, hide automatically after 2 seconds.

Attachment

Bootloader handling

Start the IC/module/device in bootloader mode

1. Switch off the IC/module/device.
2. Connect the UART adapter (USB → 3.3 volts or 5 volts UART or RS232 → 3.3 volts or 5 volts UART).
"DCF in" → UART adapter TXD and "DCF ps" → UART adapter RXD.
3. Press the button S1, power up the IC/module/device with voltage and do not release this button until you hear a short BEEP. The display is off.
4. Now you can connect to the firmware upload tool.

**WARNING****Wrong UART level**

If an incorrect voltage level (for example directly RS232, ± 12 Volt) is used, the UART adapter or the IC/module/device can be damaged or destroyed. In the worst case, overheating and fire may occur!

NOTICE**Defect firmware**

Defect firmware can be detected as follows: Every second a short BEEP.

Use the Firmware Upload Tool to upload an update

1. Download the latest upload tool from www.stefpro.biz: [SP Firmware UP](#)
2. Start the tool
3. Select the COM port.
4. Press the "Load" button and select a firmware which you have previously downloaded from SP Firmware UP
5. Now press the "Connect" button, the data from the IC / Module / device will be read and the compatibility of the new firmware with the IC / module / device will be checked
6. If an upload is possible, you can now press the "Upload Firmware" button. The upload starts and should not be interrupted.

NOTICE**Firmware upload interruption**

If the firmware upload is interrupted or uploaded an inappropriate firmware, so there is a broken firmware, the IC can be operated only in bootloader mode.

7 segment characters

The symbolism of each character:

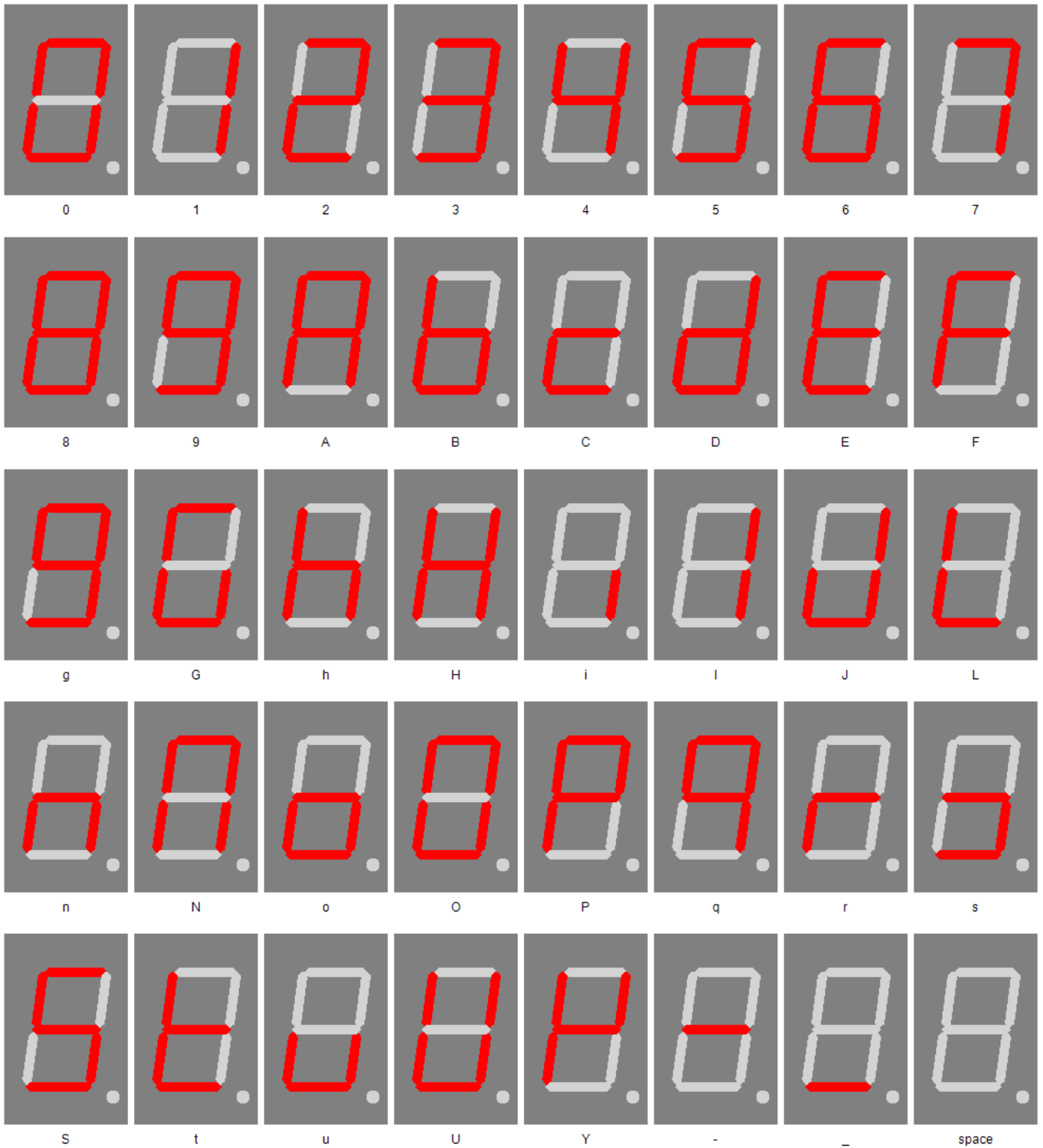

Change log

Safety

20.03.2017 - 1.0.3 - ADD
Add ESD note

DCF module properties

21.11.2016 - 1.0.1 - ADD

Add list of tested modules

20.03.2017 - 1.0.3 - ADD

Update list of tested modules, add standard pin assingment

Power supply properties

21.12.2019 - 1.0.5 - ADD

Add SNT description

Temperature sensor

22.03.2021 - 2.0.1 - ADD

Add add temperatur sensor and calibration description

Set day

23.04.2017 - 1.0.4 - ERROR

Bugfix wrong title, this sets the day not the month.

Liability, warranty and copyright notice

Definitions

- "Module": A PCB which is delivered without housing and is intended for installation.
- "Manufacturer of the whole device": The manufacturer of the whole device, the natural or legal person is mounted a device which can be made to function without special knowledge. E.G. Simple connection to the network via a euro, safety plug or by connecting to a power supply.

Liability

- Although the information contained in this document has been checked very carefully for accuracy and completeness, for errors and omissions can not be held liable. StefPro reserves the right to any time change any portion of the described hardware and software features.
- StefPro provides only specific "module" which is intended for installation. The "Manufacturer of the whole device" obliges to compliance to the relevant valided VDE, CE and EMC regulations. StefPro has verifies compliance with the requirements for this module random. Because the installation is not performed by StefPro, must additional inspection after installation of the modules by the "Manufacturer of the whole device".
- There is no liability for damages incurred directly by or in the application of the "module", as well as for damage caused by chemical or electrochemical effects of water or generally from abnormal environmental conditions.
- "Modules" by StefPro may not be used in critical equipment. At disregard exclusively the responsibility of "Manufacturer of the whole device."

These include:

- medical devices for implanting or life obtained.
 - Critical equipment for space, aerospace and traffic.
 - Other important life components or systems, where an error is fatal.
- All devices developed with a "Modules" by StefPro must be the responsibility of the "Manufacturer of the whole device" sufficiently tested to detect any defects.

Safety Notes

- Since the built module is operated with an electrical voltage, the valid VDE regulations are complied with.
- Components and modules do not belong in the hands of children!
- The module complies with the requirements of protection class III.
- The "module" may NOT directly to line voltage (or voltage > maximum operating voltage) in any case! It can be fatal!
 - Whenever it is that safe operation is no longer possible, the module / device must be taken out of service and secured against inadvertent operation. This assumption is justified,
 - when the module / device has visible damage,
 - when the module / device has loose parts
 - when the module / device no longer works
 - after prolonged storage under unfavorable conditions (eg outdoors or in moist environments)

Watch for correct voltage and connection of the "module" Voltage and / or connection mistakes are beyond our control. Thus we can not assume any liability for damages arising out of it.

Intended operation

- The used electrical parts and components are designed for a temperature between 0 °C ... +45 °C, so the device may only be operated and stored in this temperature range. It is therefore intended for use within a building, which corresponds to the specified environmental conditions. During transport, the temperature may be between -10 °C ... + 50 °C.
- If condensation has formed during transport or storage, the modules must be acclimatized for approx. 2 hours before commissioning.
- It must not be operated in an increased dust, high humidity, explosion risk or aggressive chemical exposure.
- Ensure proper operation and connection. Operating and/or connection errors are outside our area. Unfortunately, we can not accept any liability for damages resulting of this.
- The improper operation of this module may result in damage of this module, personal injury or property damage.
- The safety instructions must be observed!
- The manufacturer is not responsible for all personal injury and property damage caused by improper operation.

Warranty

- StefPro warranty only for the Modules and their firmware. The warranty is exclusively limited for the replacement of the IC within the warranty period for obvious defects in the hardware, and programming error.
- Warranty does not extend the warranty period or starts a new period again.

- Additional or deviating claims are excluded, especially claims for damages arising out of the product for damage. This will not affect claims based on inalienable rules under the product liability law.

Copyrightnotice

The circuitry and firmware to the module from StefPro is protected by copyright. Unauthorized reproduction or distribution of Modules with this program or any portion of it. This is pursued both criminal and civil law, and may result in severe penalties and compensation for damages.

Disposal information

Do not dispose devices in household garbage!

This modules or devices comply with the EU directive on electronic and electrical equipment (WEEE regulation) and therefore may not be disposed of with household waste. Dispose of the device over your local collection center for electronic equipment!



WEEE-Reg.-Nr.:

DE 58929072 (StefPro UG (haftungsbeschränkt) & Co. KG)

DE 78089358 (StefPro Einzelunternehmen bis zum 01.01.2015)

Impress

StefPro™ UG (haftungsbeschränkt) & Co. KG
- Softwareentwicklung für Prozessoren

Dipl. Ing. (FH) Stefan Nannen

Theilenmoorstr. 11

26345 Bockhorn – Germany

Phone: +49-4452-709175 (please note our [business hours](#))

Web:<http://www.stefpro.biz/>

E-mail: info@stefpro.biz