

SPM2200P

Six digit dcf clock

for small display
and extended alarm function

Datasheet

Version: Firmware 1.82-148



StefPro UG (haftungsbeschränkt) & Co. KG

Theilenmoorstr. 11
26345 Bockhorn, Germany

Phone: +49-4452-709175

Web: <https://www.stefpro.biz/>

E-mail: info@stefpro.biz

Table of Contents

Table of Contents	2
Safety	4
Application and function description	5
Product overview	5
Function description	5
Alarm Function	5
Technical data	6
Construction description	7
Pin assignment	7
Reset	7
VCC	7
AVCC	7
AREF	7
GND	7
Q1, Q2	7
N.C.	8
DCF ps	8
DCF in	8
DIS1 to DIS6	8
SEG_A, SEG_B, SEG_C, SEG_D, SEG_E, SEG_F, SEG_G, SEG_DP	8
Buzzer	8
LightSen	8
TB	8
Basic circuit	9
Properties of the components	10
7 segment displays	10
Checked displays	10
Effect of an acrylic glass	11
Calculate the series resistor for one LED	12
Calculate the series resistor for two LED	13
Keyboard	13
Button functions	13
General key functions	14
DCF module properties	14
Tested modules	14
Our standard color coding for DCF signals	14
Connection of the DCF module using a fake module	15
Without Power On / Off or Power Save input	15
With Power On / Off or Power Save input	16
Power supply properties	16
Quartz properties- Accuracy of the time	17
Buzzer properties	17
Buzzer to MP3 player	17
Properties of light sensor with Phototransistor	19
Installation the DCF clock	20
Synchronize with active display	20
Synchronize with deactivated display	20
Emitted electrical disturbances by the display	22
Test setup	22
Measurement results	22
Button description	24
Button functions	24
General key functions	24
Menu	24
Normal	25
Display mode of clock	25
Alarm	25
Alarm day selection	26
Alarm enable	26
Alarm time hour	26
Alarm time minute	27
Alarm snooze time	27
Alarm sound wait time	27
Alarm maximum time	27

Alarm exit	27
Brightness	27
Brightness menu	27
Brightness max	28
Brightness min	28
Brightness automatically	28
Brightness speed	28
Brightness factor	28
Brightness offset	29
Activate standby	29
StandBy start hour	29
StandBy end hour	29
StandBy Brightness	29
Exit brightness settings	30
DCF	30
DCF active	30
Receiving brightness	30
Hour of synchronization	30
Receive state display	30
DCF input pull up	31
DCF input invert	31
Power save pin invert	31
DCF sensitivity	31
DCF exit	32
Clock Settings	32
Set hour	32
Set minute	32
Set year	32
Set month	32
Set day	32
Day of week	33
Set time	33
Calibrate quartz	33
Exit clock settings	34
Info section	34
IC number	34
Firmware version	34
Menu end	34
Attachment	35
Bootloader handling	35
Start the IC/module/device in bootloader mode	35
Use the Firmware Upload Tool to upload an update	35
7 segment characters	36
Change log	36
Safety	36
Product overview	36
Quartz properties- Accuracy of the time	37
DCF module properties	37
Power supply properties	37
Buzzer to MP3 player	37
Set day	37
Liability, warranty and copyright notice	38
Definitions	38
Liability	38
Warranty	38
Copyrightnotice	38
Disposal information	39
Impress	39

Safety

Follow the manual



The IC is only safe in operation if all instructions are read in this datasheet.

General understanding of safety

By the IC there are no hazard under normal use.

Intended Use

The IC is designed for driving small to middle displays.

The power should come from a safe transformer (also protected transformer) or a corresponding low voltage power supply for the circuit.









Never use a higher voltage or direct mains voltage!

Concealed Hazards



DANGER

following hazards may arise in case of wrong construction of the circuit and wrong handling of IC:

-  With the direct connection to mains, it's a dangerous voltage on the IC and other components, use a safety transformer!
-  Reverse polarity and overloading the IC may cause in smoke. This smoke possibly contains toxic substances which must not be inhaled!
Ventilate the room.
-   Reverse polarity or overload of the IC can cause a hot surface on the IC or other component in the circuit.
 - There is a risk of burning when touching.
 - And flammable materials, for example Paper, can come in fire.
-  Spalling of parts on reverse polarity or overloading of the IC.
-  Wear during the initial commissioning eye protection.
-  The pins of a IC are very pointed and sharp! Therefore, this may cause in sores in case of incorrect handling.
-  Use always passing a ESD bracelet to avoid electric charges! The IC can be damaged if handling without an earthing tape and housing!

Modifications of the example circuit

The successfully built circuit may be damaged. Therefore check as appropriate all housing part and lines for damage. This applies in particular to parts of the directly (for example power cord and power supply) or indirectly come into contact with mains voltage.

Application and function description

Product overview

Here you will find an overview of the old product family of the SPM21nn and SPM22nn IC for 7 segment LED displays.

SPM2 n n n

- 1 Simple alarm function, the whole week is the same alarm time
- 2 Extended alarm function, the alarm time can be set separately on each day
- 0 One LED per segment in display, low LED current = dark
- 2 One LED per segment in display, average LED current = slightly dark
- 3 One LED per segment in display, higher LED current = bright
- 4 One to several LED's per segment in display, highest possible LED current = very bright
- 9 One to several LED's per segment in display, higher LED current = very bright
- 0 6 digit display and without temperature display in alternation
- 1 6 digit display and with temperature display in alternation
- 4 4 digit display and with temperature display in alternation

Here you will find an overview of the new product family of the SPMx22nn IC for 7 segment LED displays.

SPM2 n n n

- 2 Extended alarm function, the alarm time can be set separately on each day
- 2 One LED per segment in display, average LED current = slightly dark
- 4 One to several LED's per segment in display, highest possible LED current = very bright
- 1 6 digit display and with temperature display in alternation
- 4 4 digit display and with temperature display in alternation

Function description

This IC can analyze the DCF77 signal, which is received by a receiver and demodulated. The received time and date can output directly to a 7-segment displays. The clock synchronizes itself automatically once a day. The hour of the synchronization can be set in the menu.

The time is displayed according to DIN 5008, which means a leading 0 at the hour. 8 a.m. looks like 08:00:00 and 8 p.m. 20:00:00

Due to the 6-digit display, the date is not shown according to DIN 5008. The 24 December 2020 looks on the display like 24.12.20.

The DCF77 signal is a low frequency radio signal which transferred the time and date. It will be sent in Frankfurt am Main, derived of the local atomic clock and sent with the carrier frequency of 77.5 kHz. Therefore, these watches are also known as radio clock.

The input for the DCF77 antenna can now automatically detect whether a pullup resistor is required and whether the input has to be inverted.

With this IC an advanced alarm clock function is implemented. In this each day can be set individually.

This IC has the standard **OnChip display technology** and is suitable for small displays. These can be connected directly to the IC and require only 6 additional resistors.

This IC also has an adjustable brightness control for the display, thereby the display is easy to read during the day and at night it does not light out the entire room.

This IC has a bootloader, which allows you to update the IC firmware. This means that you will always remain at the current state of the Firmware for the IC, without further costs.

Alarm Function

With the extended alarm function in menu, for each day of the week, the alarm time and if the alarm is activated can be set. Furthermore, there are the groups week and weekend to simplify the adjustment work.

In the menu the alarm and the snooze time can be set. With the adjusted snooze time the alarm waits if the alarm is not stopped at a wake-up call, but the snooze function is activated. The maximum alarm time can be adjusted between 2 and 60 minutes.

The alarm can be activated and deactivated also outside the menu. If the wake-up call is active with S1 or S2 the alarm clock can be stopped and with S3 or S4 the snooze function will be activated.



NOTICE

Dissembled time

Because the DCF clock daily synchronized with the current DCF time, it is possible that in worst cases, an incorrect time is read and therefore the

wake-up call comes at a wrong time! Therefore, the time synchronization should eventually be placed in a time of day where it is possible to check the correct time before sleeping, if the alarm function is used.

Note: At this IC, there are no simple alarm function as described in the data sheet SPM21xx.

Technical data

- Voltage (VCC): 3 V - 5 V
- Current: 20 mA (at 5 V)
- Power: approximately 100mW (at 5 volts)
- Number of Pins: 28
- Display Power: directly to the controller is the maximum LED current 40mA
- Clock frequency: 8MHz
- Accuracy of the timer: better uncalibrated 99.9 %; calibrated better 99.999 %
- Other properties, refer to the datasheet for Microchip® ATmega328 or ATmega328P

Construction description

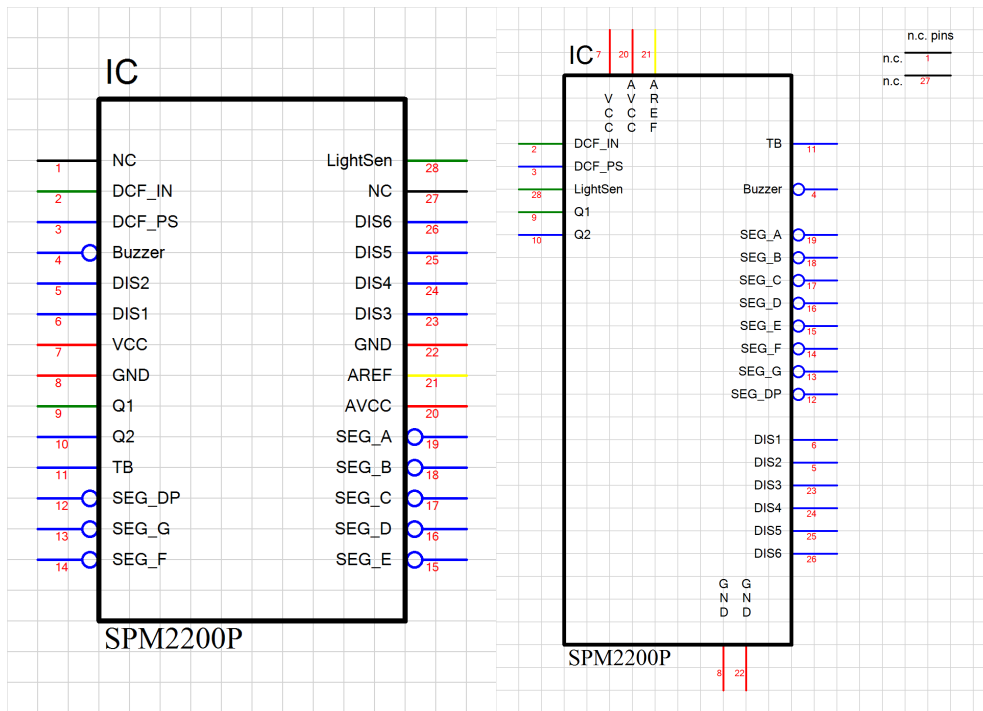

Pin assignment

Reset

Reset input to reset the microcontroller is normally not required. In case of higher EMC requirements a 100nF capacitor should be soldered to ground!

VCC

Operating voltage (3 V - 5 V)

AVCC

Analog operating voltage ($VCC \pm 0.3 V$), there should be a coil with about $10\mu H$ connected between VCC and AVCC.

AREF

Internal analog reference voltage should be blocked with a 1 nF ceramic capacitor

GND

Ground

Q1, Q2

The connecting of the 8MHz quartz is shown in Figure 1

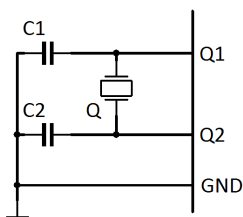

Figure 1: Connection of quartz

C1 and C2 are 20pF to 27pF ceramic capacitors (depending on the quartz) Q is an 8MHz quartz

N.C.

Do not connect, connect to no other signal!

DCF ps

DCF Modules Enable pin, this pin enables the DCF modules when needed. Whether the pin is LOW or HIGH active can be set in the menu.

DCF in

Input for the DCF77 antenna. Inverting can be adjusted automatically or manually. Pull up resistor can be switched on in the menu.

DIS1 to DIS6

The respective anode 7-segment display. DIS6 is the tens of hour and DIS1 the ones digit of seconds. DIS6 simultaneously provides the mass for the button. Should be wired as in the wiring diagram of the basic circuit.

SEG_A, SEG_B, SEG_C, SEG_D, SEG_E, SEG_F, SEG_G, SEG_DP

Cathode terminals for LED segments of the 7-segment displays. Furthermore keys are connected to Seg A, Seg B, Seg C, Seg D .

Buzzer

On this connector a buzzer can be connected as an acoustic alarm optional. The plus pole must be connected to VCC pin of the buzzer, the minus pin must connected with "Summer".

LightSen

Analogue input for a light sensor.

TB

Tap to verify the accuracy of the time base, min. 0,999 99 kHz and max. 1.000 01 kHz, the larger is the different from the 1 kHz the less accurate the IC. Production pin. The quartz can be adapted by firmware, see menu item "Calibrate quartz" or by adapting the quartz capacitors.

Basic circuit

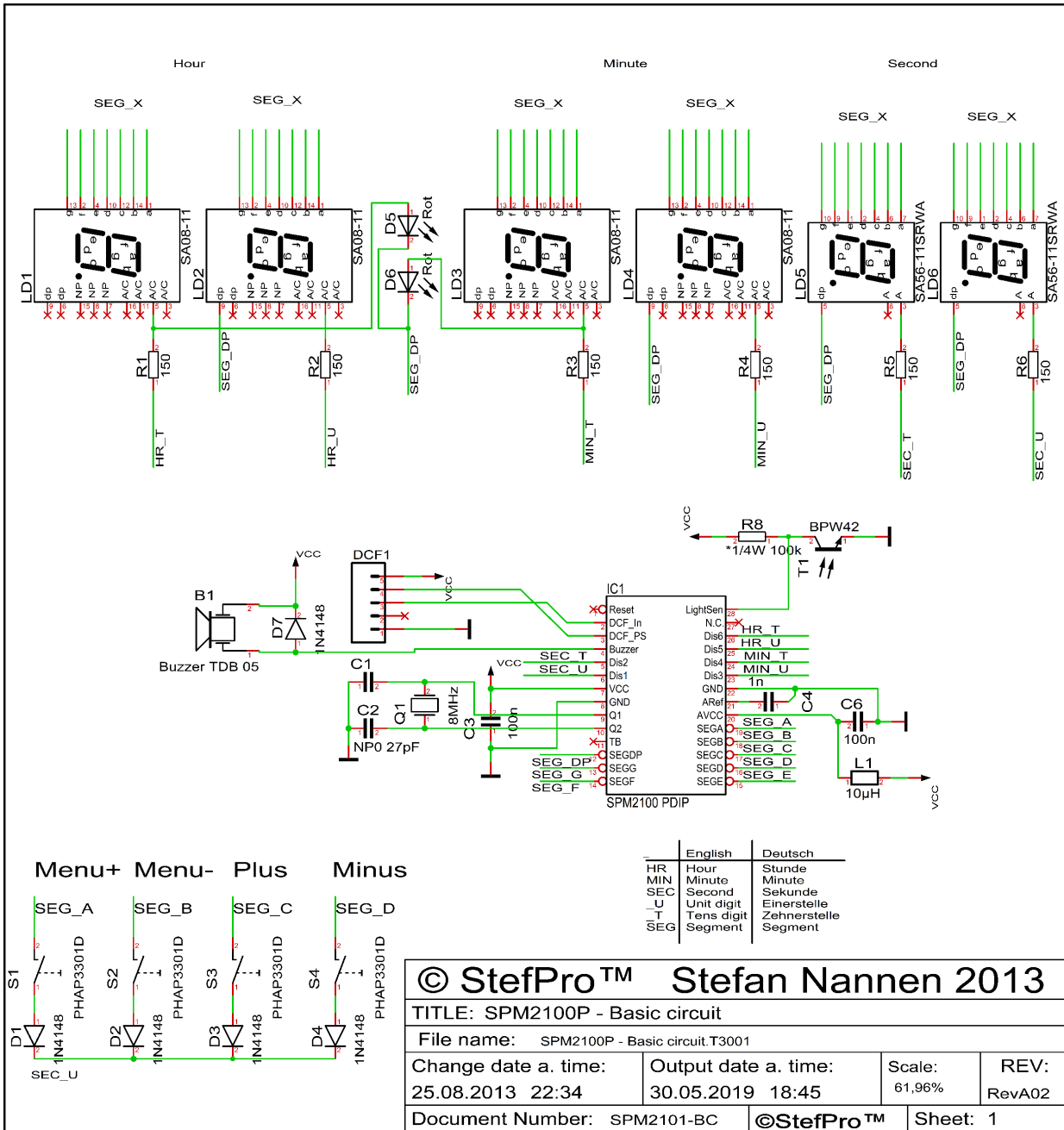
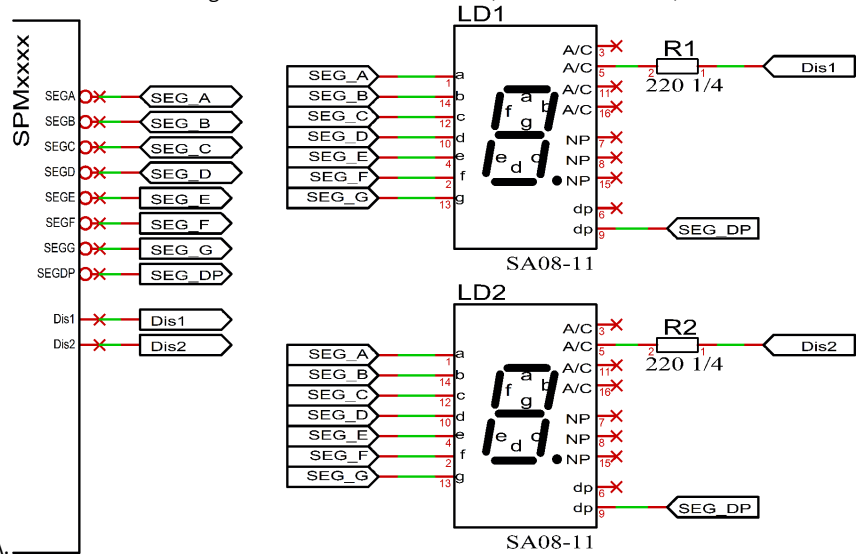

Figure 2: Basic circuit of SPM2200P

Properties of the components

7 segment displays

The seven-segment display LD1 must have a common anode. Via R1 the brightness of the LEDs can be set, it should be noted, that the maximum



current with direct control by the SPM2200P is 40 mA.

Checked displays

Manufacturer no. Hersteller-Nr.	Manufacturer Hersteller	Color Farbe	Current Strom	Brightness Helligkeit
0.39 in - 10mm				
SA 39-11 SRWA	KINGBRIGHT	Red- Rot	32mA	✓
SA 39-11 GN	KINGBRIGHT	Green- Grün	28mA	—
0.52 in - 13,3 mm				
SA52-11SRWA	KINGBRIGHT	Red- Rot	32mA	✓
SA52-11LSRWA	KINGBRIGHT	Red- Rot	32mA	(Minimal brighter - Minimal heller)
SA52-11EWA	KINGBRIGHT	Red- Rot	30mA	—
SA52-11YWA	KINGBRIGHT	Yellow- Gelb	29mA	✗
SA52-11LYWA	KINGBRIGHT	Yellow- Gelb	29mA	✗
SA52-11GWA	KINGBRIGHT	Green- Grün	28mA	—
SA52-11LGWA	KINGBRIGHT	Green- Grün	28mA	—
SA52-11QBWA-D	KINGBRIGHT	Blue- Blau	10mA	✓
LTS-546AP	Lite-On	Red- Rot	~30mA	✗
TDSR5160	Vishay Semiconductors	Red- Rot	~30mA	✗
TDSG5150	Vishay Semiconductors	Green- Grün	28mA	✓
0.56 in - 14,2 mm				
SA 56-11 EWA	KINGBRIGHT	Red- Rot	32mA	✗
SA 56-11 GWA	KINGBRIGHT	Green- Grün	28mA	✗
0.8 in - 20,32 mm				
SA08-11SRWA	KINGBRIGHT	Red- Rot	32mA	✓
SA08-11EWA	KINGBRIGHT	Red- Rot		Testis still pending - Test steht noch aus
SA08-11YWA	KINGBRIGHT	Yellow- Gelb	29mA	✓
SA08-11GWA	KINGBRIGHT	Green- Grün	28mA	✗
SA08-11PBWA	KINGBRIGHT	Blue- Blau	10mA	—
HDSP-8601	Agilent	Green- Grün	28mA	—
2.3 in - 56,9 mm				
SA23-12SRWA	KINGBRIGHT	Red- Rot	-	✗ (impossible- unmöglich)
SA23-12EWA	KINGBRIGHT	Red- Rot	-	✗ (impossible- unmöglich)
SA23-12YWA	KINGBRIGHT	Yellow- Gelb	-	✗ (impossible- unmöglich)
SA23-12GWA	KINGBRIGHT	Green- Grün	-	✗ (impossible- unmöglich)
4.0 in - 100 mm				
SA40-19SRWA	KINGBRIGHT	Red- Rot	-	✗ (impossible- unmöglich)
SA40-19EWA	KINGBRIGHT	Red- Rot	-	✗ (impossible- unmöglich)
SA40-19YWA	KINGBRIGHT	Yellow- Gelb	-	✗ (impossible- unmöglich)
SA40-19GWA	KINGBRIGHT	Green- Grün	-	✗ (impossible- unmöglich)

- ✓ Works fine. The input voltage of the module may need to be adjusted, we will be happy to advise you. Please note that the ambient brightness can unfortunately reduce the impression of brightness somewhat.

Funktioniert perfekt. Die Eingangsspannung des Moduls muss ggf. angepasst werden, wir beraten Sie gerne. Bitte beachten Sie, dass die Umgebungshelligkeit den Helligkeitseindruck leider etwas mindern kann.

- Works but not fine - Funktioniert, aber nicht zu empfehlen

- X Doesn't work - Funktioniert nicht
- X Not tested, would not work directly - Nicht getestet, da nicht direkt möglich.

Effect of an acrylic glass

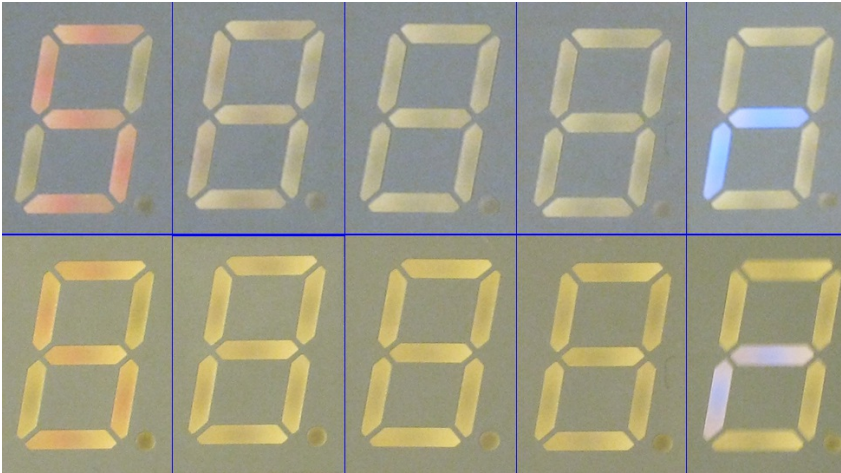

Figure 3: Differences of display readability brightness level 1

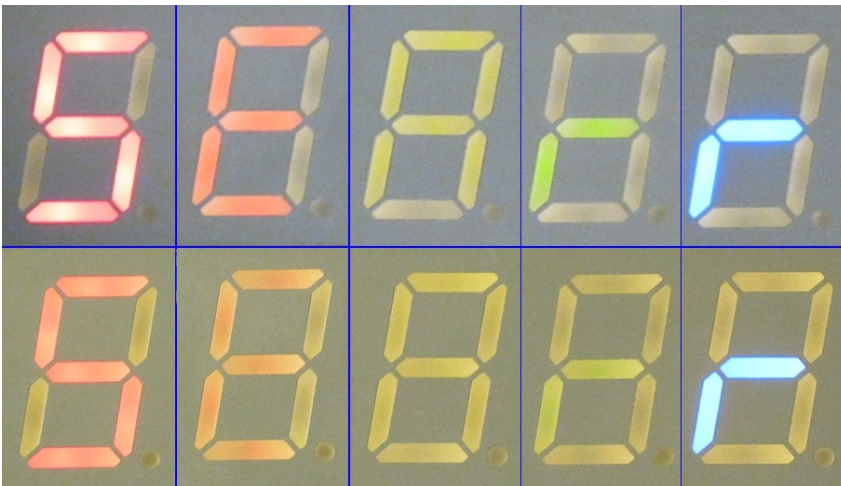

Figure 4: Differences of display readability brightness level 25

The displays in figure 3 and 4 are from left to right:

- SA52-11SRWA
- SA52-11EWA
- SA52-11YWA
- SA52-11GWA
- SA52-11QBWA-D

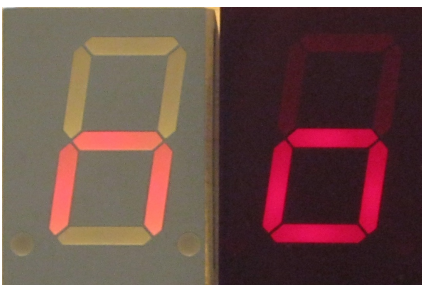

Figure 5: SA08-11SRWA left without and right with contrast pane with back light.

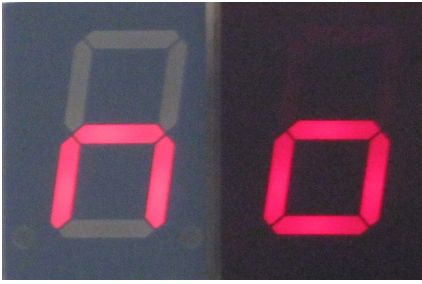

Figure 6: SA08-11SRWA left without and right with contrast pane without back light.

Below with and above without back light.

Because the displays are multiplexed (only one LED is lights at the same time for a maximum of 5 microseconds) to minimize component count and power consumption, not all 7-segment displays are usable.

Also note, that the displays which can work with 10 mA constant current, not implicitly work with 10 mA pulsed current. All displays have been limited with a 100 ohm resistor.

The brightness of the display is designed for the brightness conditions in a living room or laboratory. Since the circuit is optimized for minimum components and power consumption, the readability is limited with direct irradiation by spotlight or sunlight without a contrast panel very limited and with better.

It is recommended to place a contrast glass in the corresponding display colour in front of the displays, see figure 6 and 5.

Correct colour of the glass.

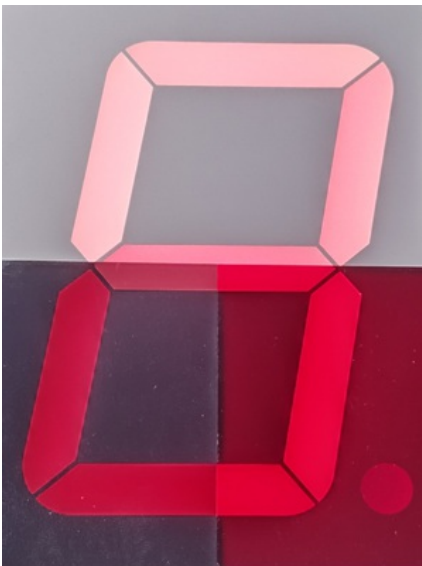

Figure 7: SA40-19SRWA top without, bottom left grey and right with red contrast lens with front light

SPI contrast without front light 2

Figure 8: SA40-19SRWA upper red and lower gray contrast pane with front light.

The colour of the disc also makes a difference, see 7 and 8 with 20,000 lux front light. Note: The menu is always displayed with 100% brightness.

Calculate the series resistor for one LED

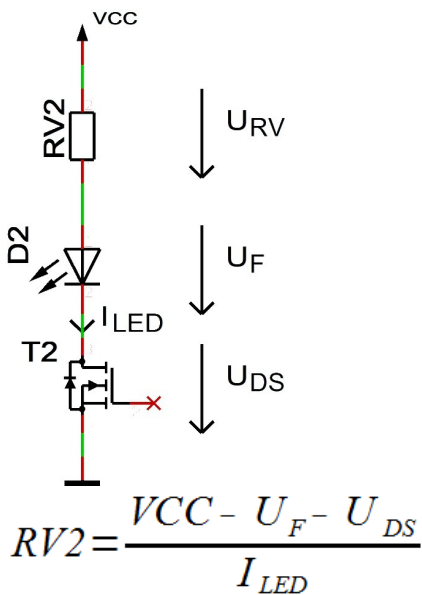

- $U_{DS} \approx 0$
- $I_{LED} < 35 \text{ mA}$

Calculate the series resistor for two LED

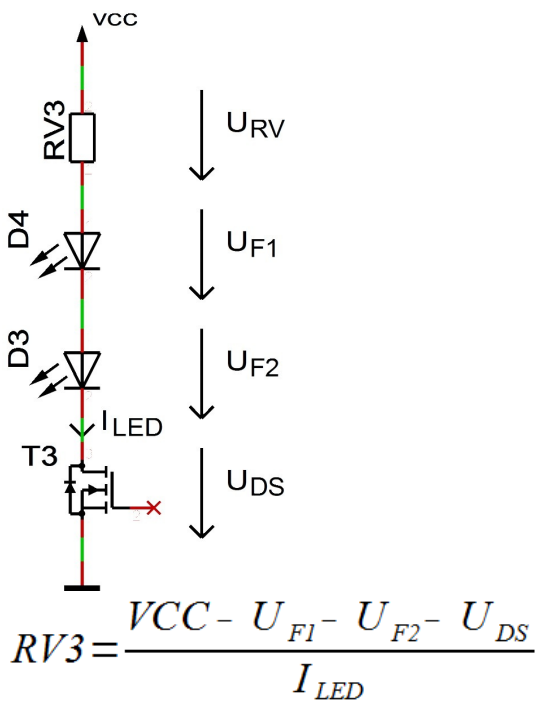

- $U_{DS} \approx 0$
- $I_{LED} < 35 \text{ mA}$

Keyboard

Button functions

The keyboard consists of three to four buttons. It is expressly recommended to use digital compatible switches. The diodes D1 to D4 are for blocking display faults when pressing 2 and more keys.

The remote control of the controller is simply possible by parallel adding or replacing the button with NPN transistors.

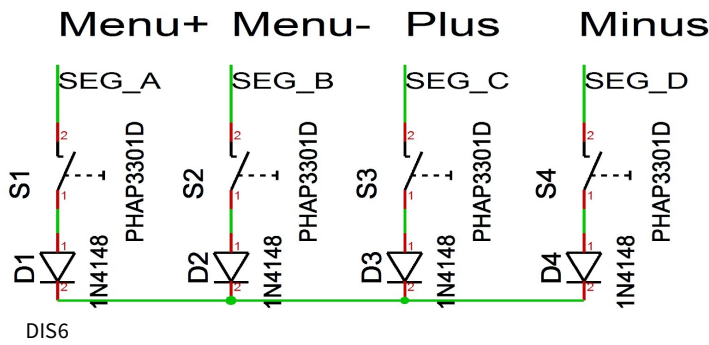

- Menu Opens the menu, next setting
- Plus or + Function key, usually +, On or jump into and exit a submenu
- Minus or - Function key, in general - or off

Which button assignment to which pin, please refer to the example diagram.

To open the menu you have to press the menu or StartStop button for a long time. Use the menu button to navigate forward.

General key functions

- A submenu is always opened with the "Plus" or "+" key and with menu display "... E" it can be exited again with "Plus" or "+".
- For numerical properties, the number is increased with the "Plus" or "+" key and decreased with the "Minus" or "-" key.
- If it is an On / Off property, then "Plus" or "+" sets On and "Minus" or "-" sets Off.
- With lists, the value is changed according to the order with the "Plus" or "+" button, with "Minus" or "-" this happens in the opposite way.
- In special cases, this is described in detail next to the images.

DCF module properties

- The module has to be able to work with an operating voltage of 5V (some modules have an operating voltage range of 1.2 to 15 volts, these are also usable)
- The output has to be able to drive a CMOS input with a input impedance of 10kΩ
- For DCF modules with open collector (open collector) or open drain output the input detected automatically by default whether a pull-up resistor is required. In menu a pull-up resistor can be connected or disconnected permanently.
- Polarity of the output:
 - The output has to be non inverting, the high state has to be 100ms or 200ms
 - The output has to be inverting, the low state has to be 100ms or 200ms
 - The receiving LED should at good reception signal flash every second for 100 ms and 200 ms. Does the receiving LED goes off every second for 100 ms and 200 ms, then the polarity is wrong. Unfortunately, you then connected a wrong module, this can't be analyzed with the microcontroller.
 - Whether the output is non inverting or inverting, is detected automatically by default or can be set in the menu.
 - The receiving LED should at good reception signal flash every second for 100 ms and 200 ms. Does the receiving LED goes off every second for 100 ms and 200 ms, then the polarity is wrong. To correct this, you has to be invert the setting for the inverting DCF input pin in the menu. (Instead of on → off → on or off)
- The DCF module can have a power on / off pin. Then the DCF module is automatically switched off when the DCF signals from the microcontroller are not analyzed. In the menu can be set if the DCF module is with low or high on.

Tested modules

Module	GND	VCC	DCF input	PowerSave output	Comment
Conrad DCF Modul	1 (GND)	2 (Betriebs...)	3 (DCF Ausgang)	-	
ELV DCF Modul	3 (Masse)	1 (+ UB)	2 (Signal-Ausgang)	-	
Pollin DCF Modul	GND	VCC	DATA	PON	Caution An additional circuit is required for an operating voltage of more than 3.3V!

Our standard color coding for DCF signals

- GND: black
- VCC: rot
- DCF input: green
- PowerSave output: white (is not supported by each DCF receive module)

You can usually also supply the DCF receiver via the PowerSave output. But in this case you must ensure that this output is not inverted in the menu and that the pin must not be permanently loaded with more than 20 mA.

Connect the DCF module with approx. 10 cm wire, it is best to select the colors as in the table above, so that this can be mounted at some distance from the display.

WARNING	
Please check the pin assignments! It is not in our hands whether the manufacturers of the DCF receive modules change the pin assignments at a later date.	

Connection of the DCF module using a fake module

Here you will find some examples for the wiring of the DCF modules, as already mentioned, some strands are intended for wiring.

Without Power On / Off or Power Save input

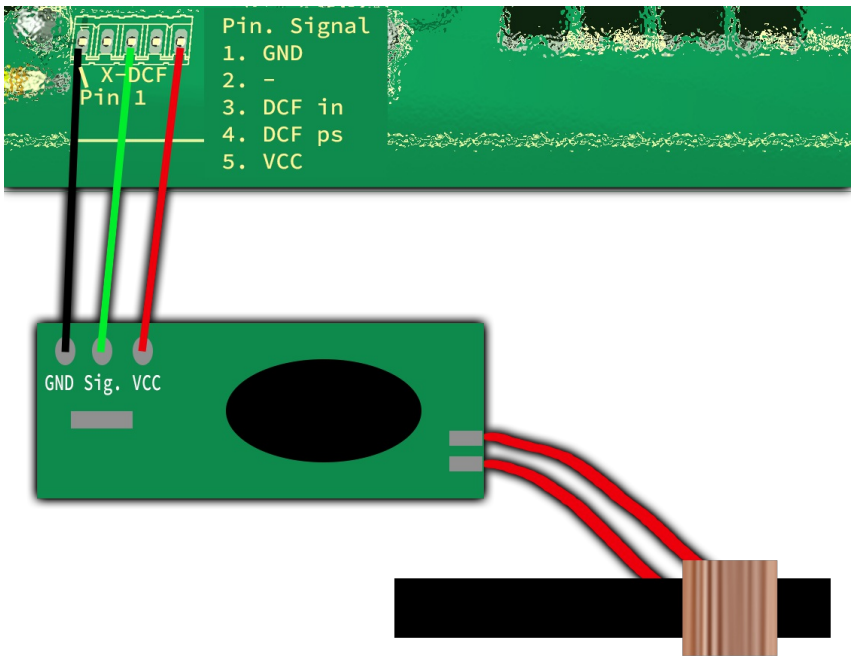

Figure 9: DCF connection to VCC

In the figure above you can see the classic wiring of the 5-pin pin strip and the DCF receiver module. Here the receiving module is permanently supplied with 5 volts or VCC and therefore also permanently supplies a signal.

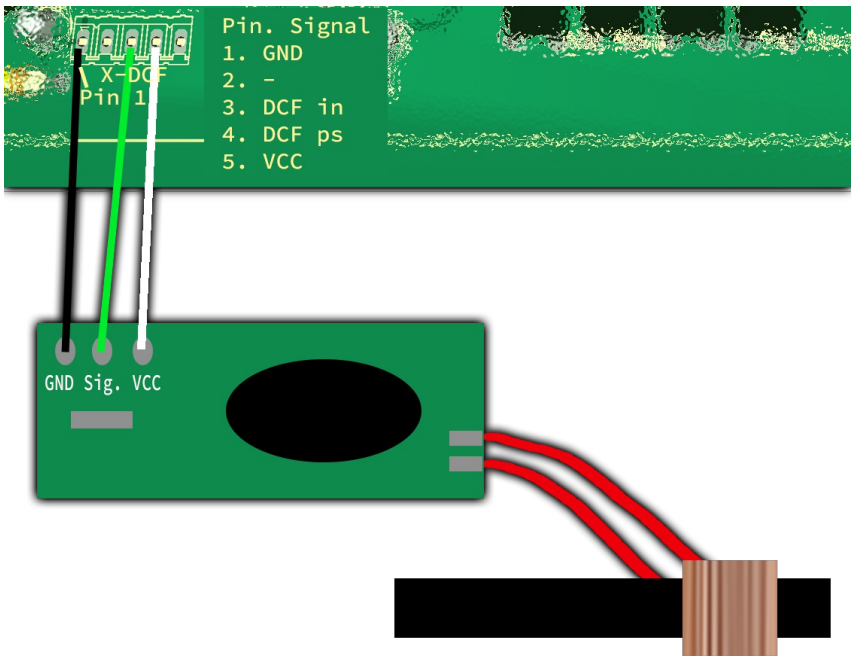

Figure 10: DCF connection with PowerSave

In this figure above you can see a wiring with the PowerSave signal as VCC for the DCF receiving module. Here the receiving module is only supplied with voltage while the analysis is being carried out. When using this, make sure that the setting in the DCF menu does not invert the PowerSave output (see "Power save pin invert")!

With Power On / Off or Power Save input

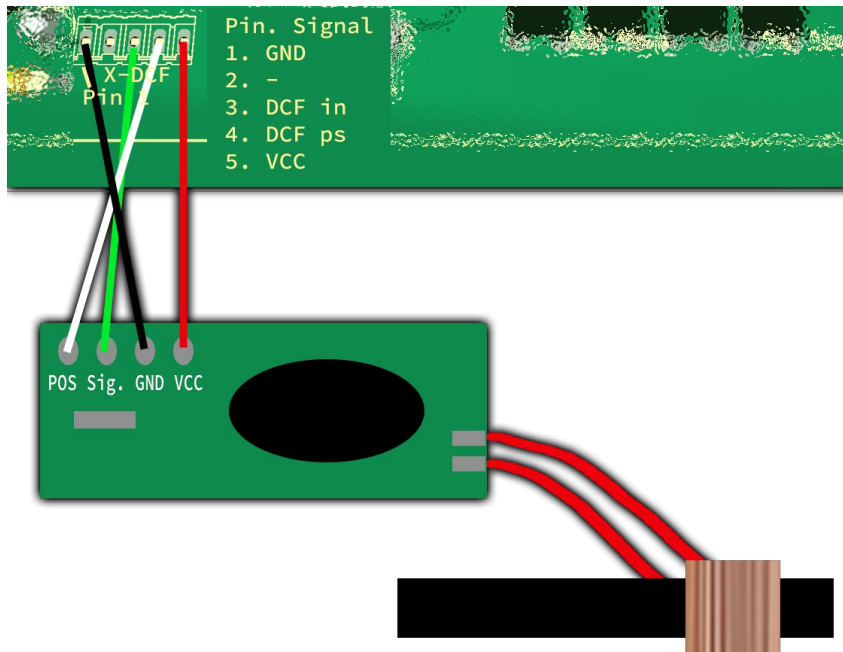

Figure 11: DCF connection with VCC and PowerSave

Here you can see the wiring with VCC and the PowerSave signal. Here the receiving module is only switched on while the analysis is being performed. A supply of voltage is permanent.

Power supply properties

Since the clock is usually to be operated on a 230 volt power supply, a power supply unit is required. This can be a normal transformer power supply or a switching power supply.

Transformer power supply:

- Pro:
 - Cheap
 - Little interference for DCF reception
- Contra:
 - Heavy
 - Depending on the power is it big
 - Poor efficiency
 - Even if the circuit requires little power, some power may be needed
 - Higher electricity costs

Switching Power Supply:

- Pro:
 - Light
 - Small
 - Good efficiency is possible
 - Standby possible with very low power requirements
 - Lower electricity costs than with the transformer power supply
- Contra:
 - Larger interference for DCF reception
 - Usually a little more expensive

Switching power supplies should be preferred, unfortunately they have the disadvantage that many can interfere with the DCF reception and the DCF clock is not synchronized. Switching power supplies with a PE feedthrough (PE is connected to ground) often have better interference behavior, but this cannot be generalized. The switching power supplies offered in our shop have been tested and only minimally interfere with DCF reception.

Use only a power supply unit with electrical isolation!

Quartz properties- Accuracy of the time

The quartz, microcontroller, quartz capacitor combination decisively determine the accuracy of the clock. Since only the controller is supplied, prior coordination is not possible.

The accuracy can be measured on the TB pin, which can be found in the pin assignment. If the clock is inaccurate, first check the soldering points of the quartz, the quartz capacitors and the controller. These solder points must be correctly soldered and dirt such as Flux should be removed.

You can carry out a calibration yourself with the appropriate measuring equipment or you can order it from us with cost. Check the [items in our shop](#).

To carry out the calibration, measure on pin TB with a multimeter, which frequency or period measurement can or with a frequency meter the output frequency. This should be as accurate as possible at 1 kHz or 1ms (for period measurement). A long gate time (duration of the frequency measurement) is advantageous because the interrupts create a little jitter (slight variation in the frequency). The calibration can be done digitally in firmware in somewhat rough steps in the menu "Calibrate quartz" or with a trim capacitor (this is not listed in a kit or parts list) in very fine steps. The best result is achieved by a trimming capacitor. However, since these are rarely produced, they are expensive and the increase of accuracy is minimal. Furthermore, for trimming capacitors you need a good tactile adjustment tool, a "normal" screwdriver usually does not work.

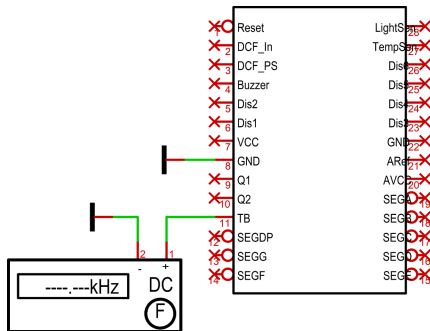

Figure 12: Calibrate quartz

NOTICE

Of course, the measuring device must have a corresponding accuracy.

Add quartz properties, how to calibrate.

Buzzer properties

The buzzer B1 must be self-producing and have a minimum voltage of VCC. Does the buzzer have not VCC, a series resistor have to be installed. The buzzer may further maximum of 40mA directly from the IC SPM2200P. The plus pole of the buzzer have to be applied to VCC and the minus pin of the buzzer have to be connected to the IC. D1 is the idle diode when operating with coils.

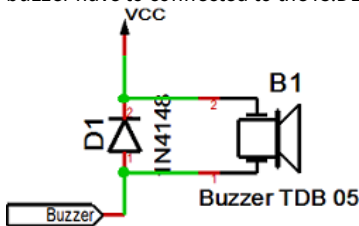

Buzzer to MP3 player

If an MP3 player is to be used instead of a self-exciting buzzer, a small circuit must bridge the signal off time.

This is possible with this very simple circuit, with a NE555, build-up as a retriggerable mono-flop.

Furthermore, there is a small power supply for the MP3 module, because most of the imported modules requires a voltage supply of 5 volts. The current is still acceptable with a connected 4 Ohm loudspeaker for a 7805 with heat sink and a current of 200 to 500 mA, since the alarm should not play for more than 30 min. However, it is also possible to use a PIN compatible DCDC converter by different manufacturers.

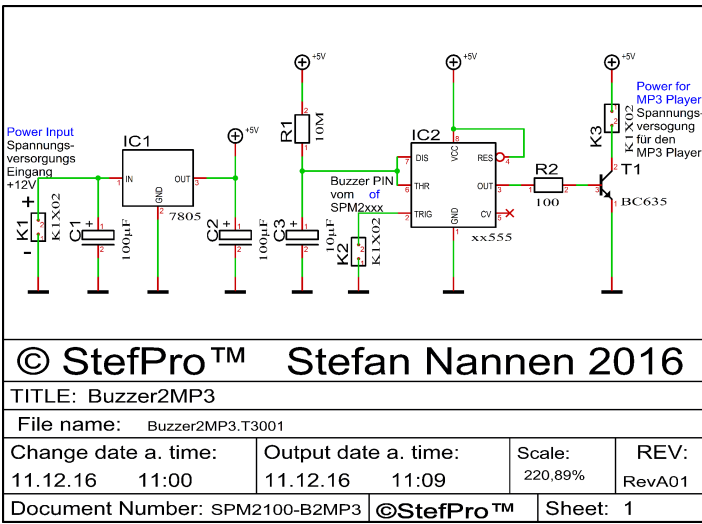

Combination R1 and C3 gives a mono time of approx. 2 min.

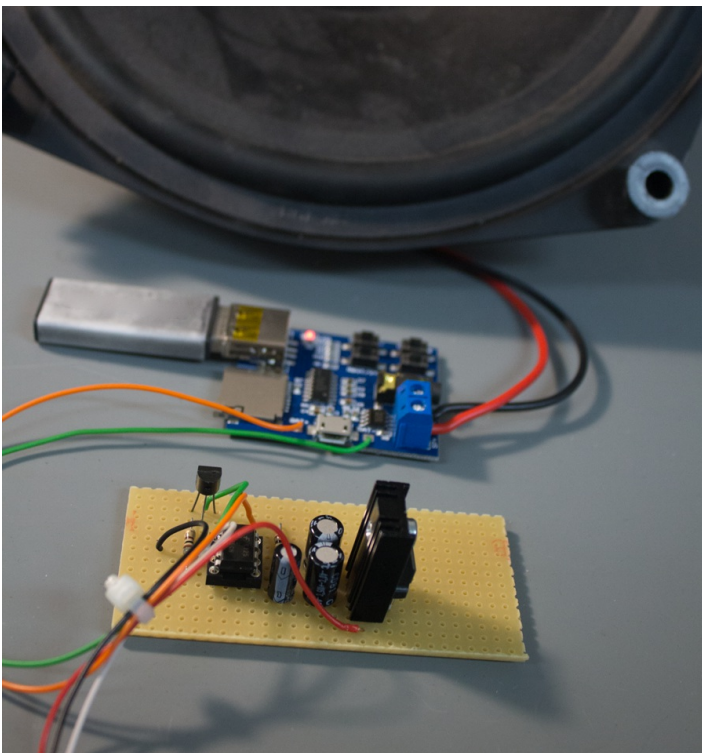

Colors of thin wires:

- red: plus supply voltage (<= + 12 Volt)
- black: minus supply voltage
- white: Buzzer signal from the IC SPM2200P
- orange: plus MP3 Player Module (+5 Volt)
- green: minus MP3 Player Module

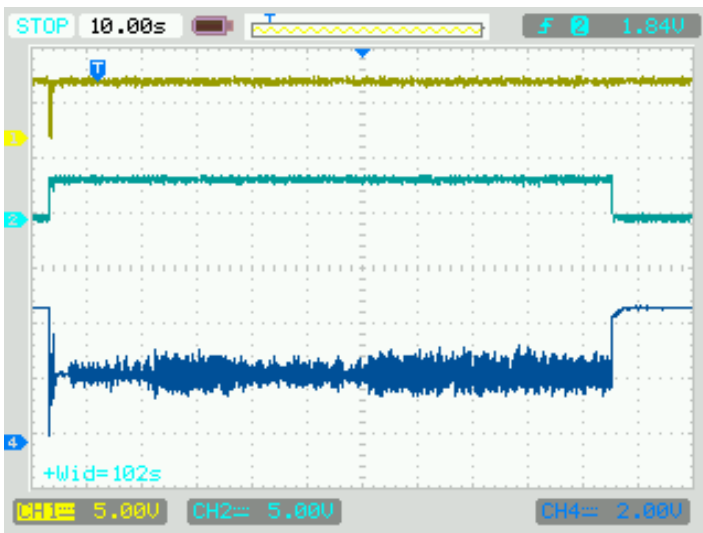

Colors of the signals:

- yellow: Trigger signal
- light blue: MP3 Player Power Supply
- dark blue: Output from the MP3 Player

Properties of light sensor with Phototransistor

The light sensor is used to control the brightness of the display. As light sensors many phototransistors are suitable, in the example circuit a BPW42 is used. If another phototransistor is used, you may need to change the value of the pull-up resistor R1. The menu allows to adjust the calculation factor, offset and the control speed. If the sensor is mounted behind a contrast panel, it must be taken to ensure that the wavelength of the phototransistor can pass through the contrast screen.

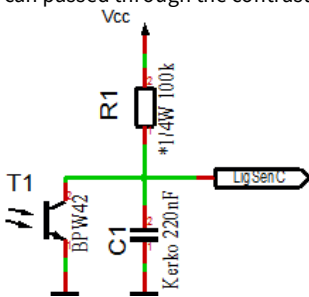

In the case of the BPW42 and similar photo transistors in the LED diode housing, the incidence of light must take place as follows in order to achieve the best result:

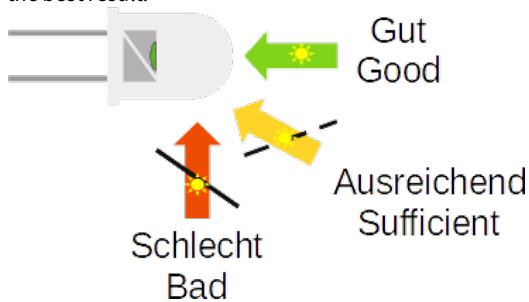

NOTICE

When using a different phototransistor or a different photodiode, it may be necessary to adapt R1 (top picture) and the settings in the menu!

Installation the DCF clock

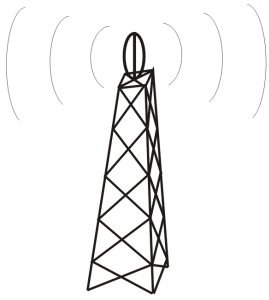

Sender in Frankfurt



DCF77-Antenne

Figure 13: Align the DCF antenna

The external antenna receives the DCF77 signal and should be directed to Frankfurt, as shown in Figure 13. The antenna should be placed at least 1 meter away from a monitor, computer or other disturbing electronic devices .



During installation, the receiving LED can be used as an orientation to the quality of reception. The LED should flash at intervals of one second. If the antenna is properly aligned and the signal is strong enough, the display changes of „no signal,, (No impeccable DCF77 signal) in „SEArCH,, (search for the 59th second). Was the 59th second found so will the display shows „rEAd60,, (read the DCF time) henceforth. It still takes 60 seconds to display the correct time. If the clock is not synchronized to the DCF time, the receiver LED flashes DCF work cycle (power reserve is in operation), if the LED is enabled in the menu. Is the display not changed to „SEArCH,, the antenna is probably disturbed by a device or the antenna is too close to the display. Because the DCF antenna is so sensitive that it can disturb by the display in the near field, there is the possibility to reduce the brightness of the display during the synchronization, or to deactivate the display. This problem have all other DCF clocks with multiplexed LEDs displays also. By a darker display the DCF antenna can be mounted significantly closer to the display.

Synchronize with active display

This mode is active when in menu under "receive brightness" the brightness is set > 0. Appearance of the text on the screen:

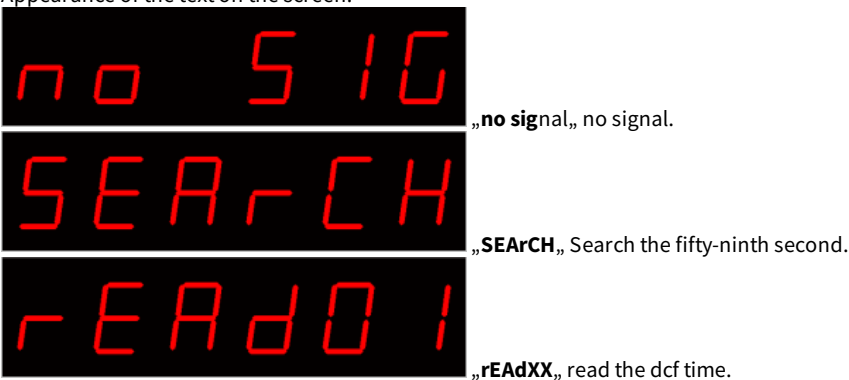

Synchronize with deactivated display

This mode is active when in menu under "receive brightness" the brightness is set to 0. When synchronizing with disabled display, only one decimal point for orientation appears.





„**SEArCH**„ Search the fifty-ninth second.



„**rEAdXX**„ read the dcf time.

Emitted electrical disturbances by the display

In the near field generates the display, by the fast on and off switching of the LEDs, disturbances. These depend on the brightness of the display. For EMC / CE conformity these disturbances are uninteresting because they are strong only in the near field and occur only under 30 MHz. For sensitive antennas as a DCF77 antenna these disturbances may be problematic, because this increases the distance between the antenna and the display.

To illustrate, a few simple relative measurements were performed with an oscilloscope:

Test setup

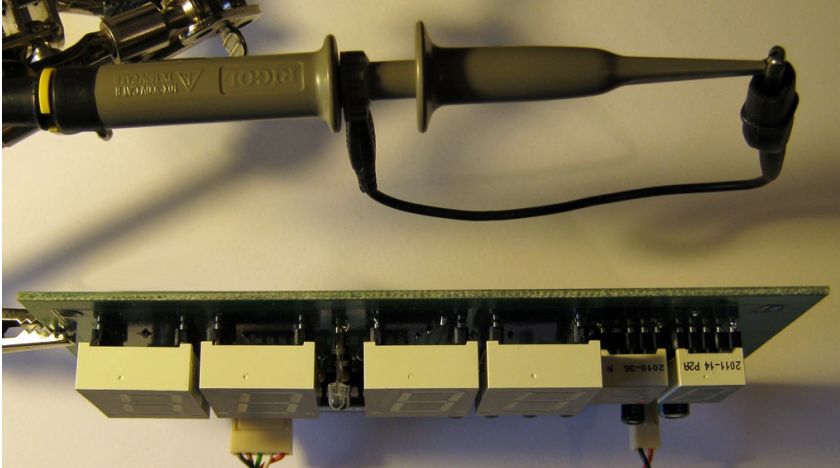

Figure 14: Test setup for the measurement

Measurement results

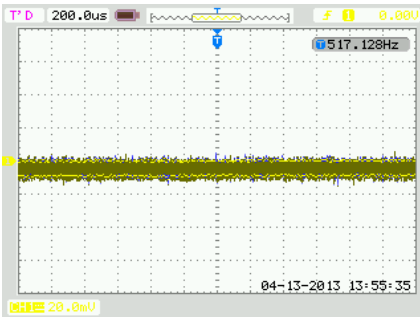

Figure 15: Measurement display is switched off

Figure 15 the display is off, only a decimal point indicates the synchronization status of the DCF time. The "Receive brightness" is on brightness level 0

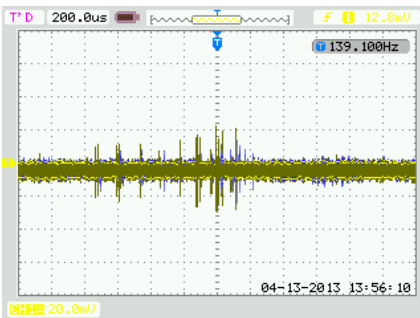

Figure 16: Measurement with brightness level 15

Figure 16 shows the display brightness set to 15 and there will be something displayed. It can be seen slight disturbances in the near field.

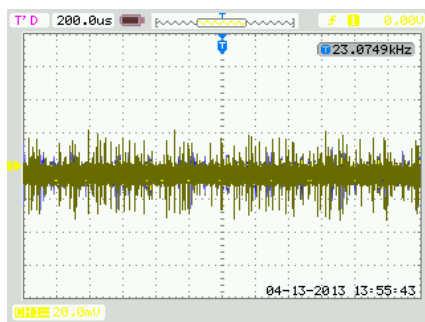

Figure 17: Measurement with brightness level 25

Figure 17 shows on the display brightness set to full brightness level 25 and it will be something displayed. There can be seen big disturbances in the near field.

The measurements were performed with an oscilloscope with 200 MHz bandwidth, a probe 10/1 (in order to obtain the full range) and PeakDetect. It was used the circuit SPP2100.

Button description

Button functions

Menu+	Opens the menu, next setting
Menu-	Opens the menu, previous setting
Plus or +	Function key, usually +, On or jump into and exit a submenu
Minus or -	Function key, in general - or off

Which button assignment to which pin, please refer to the example diagram.

To open the menu you have to press one the menu buttons. Use the menu+ button to navigate forward and the menu- button to navigate backward.

General key functions

- A submenu is always opened with the "Plus" or "+" key and with menu display "... E" it can be exited again with "Plus" or "+".
- For numerical properties, the number is increased with the "Plus" or "+" key and decreased with the "Minus" or "-" key.
- If it is an On / Off property, then "Plus" or "+" sets On and "Minus" or "-" sets Off.
- With lists, the value is changed according to the order with the "Plus" or "+" button, with "Minus" or "-" this happens in the opposite way.
- In special cases, this is described in detail next to the images.

Menu

Level 1	Level 2
Normal ↓	
Display mode of clock ↓	
Alarm ↓	Alarm day selection → Alarm enable → Alarm time hour → Alarm time minute → Alarm snooze time → Alarm sound wait time → Alarm maximum time → Alarm exit ↻
Brightness ↓	Brightness menu → Brightness max → Brightness min → Brightness automatically → Brightness speed → Brightness factor → Brightness offset → Activate standby → StandBy start hour → StandBy end hour → StandBy Brightness → Exit brightness settings ↻
DCF ↓	DCF active → Receiving brightness → Hour of synchronization → Receive state display → DCF input pull up → DCF input invert → Power save pin invert → DCF sensitivity → DCF exit ↻
Clock Settings ↓	Set hour → Set minute → Set year → Set month → Set day → Day of week → Set time → Calibrate quartz → Exit clock settings ↻
Info section ↓	
IC number ↓	
Firmware version ↓	

↓: Next step in main menu. →: Next step in sub menu. ↻: The submenu starts again.

Normal

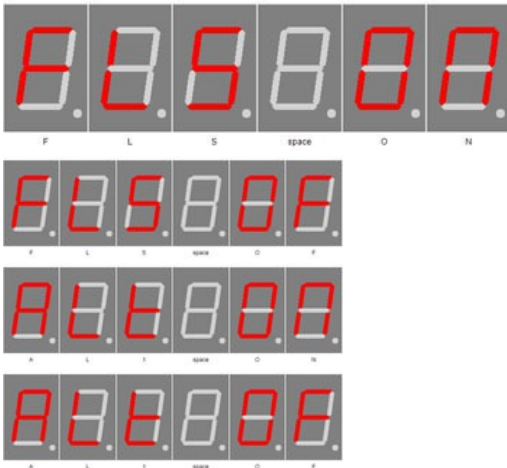

Normal mode, outside of the menu.

Here the plus (+) button has the function of the alarm temporary switch on or off.

The minus (-) key switches the display back to 100 % (flashlight, automatic brightness control is switched off) or to normal brightness.

Display mode of clock

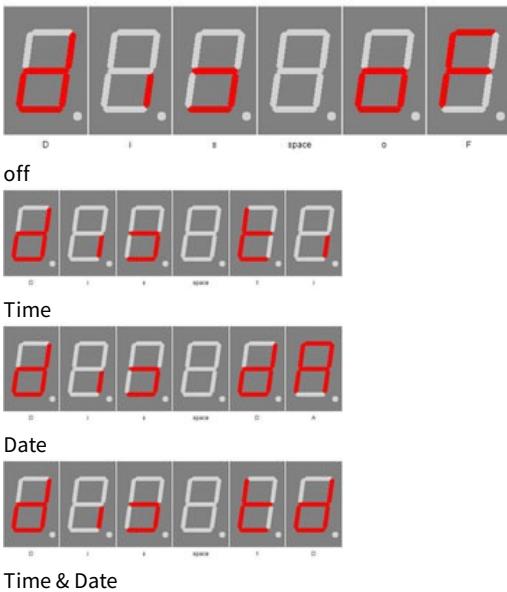

Use plus (+) and minus (-) to set the mode how to display time and date.

- OF: Does not display the time / date. When the temperature display is active, the temperature is displayed continuously. If no temperature display is possible or active, dashes (-) are shown in the display.
- ti: Shows only the time.
- dA: Shows only date.
- td: Shows time and date alternately.

Alarm

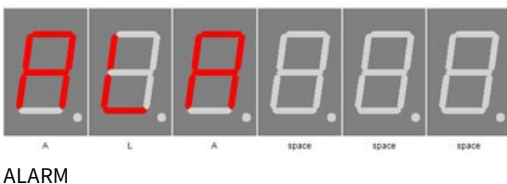

With plus (+) you enter the sub-menu Alarm.

Alarm day selection

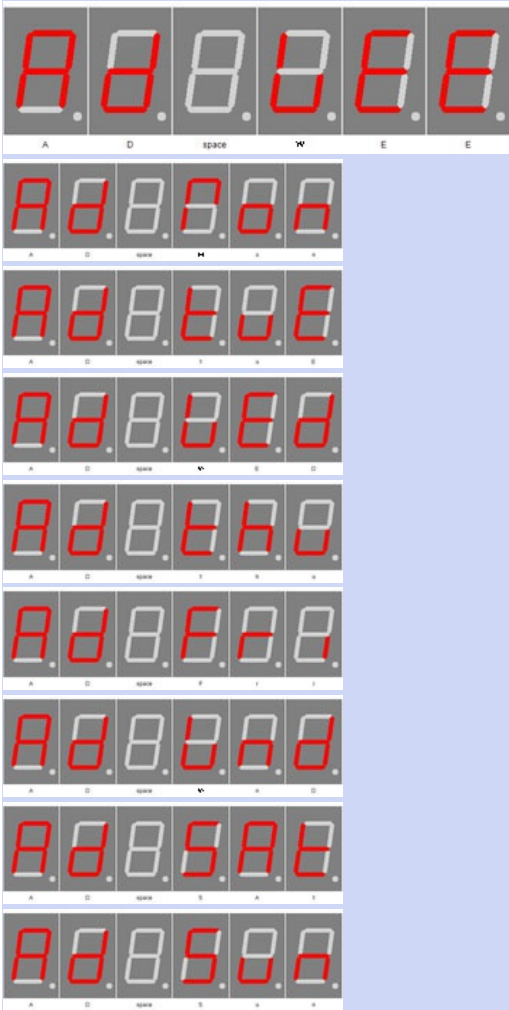

Use plus (+) and minus (-) to select the day or which group is to be edited. There are the group Week (WEE) and weekend (wnd). Saturday and Sunday are in the group weekend, all other days are in the group week. Through these groups, it is possible to set the alarm for several days at once. If the alarm is active for the week, so the weekdays can no longer be adjusted individually and inheriting the groups setting. A decimal point indicates whether the alarm on the day or group is active.

Alarm enable

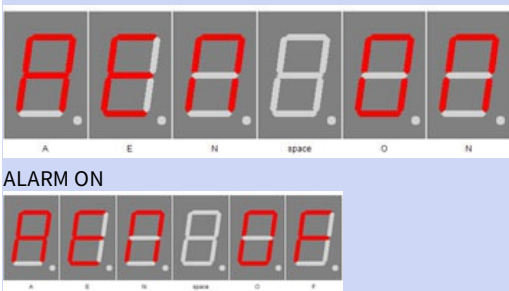

Enables the alarm. Plus (+) sets the alarm to "AEN ON" and minus (-) sets it to "AEN OF".

Alarm time hour



Use plus (+) and minus (-) to set the hour for alarm. The number can be 0-23

Alarm time minute



Alarm minute

Use plus (+) and minus (-) to set the minutes for alarm. The number can be 0-59

Alarm snooze time

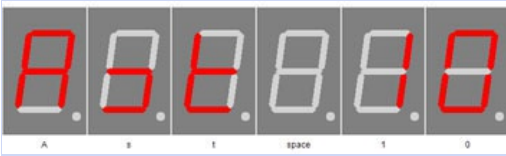

Alarm snooze time

Use plus (+) and minus (-) to set the minutes for the snooze function. The number can be 1-30

NOTICE

If "alarm maximum time" is shorter than alarm snooze time, the snooze function is disabled!

The snooze function can be activated in alarm/wake-up mode with plus (+) and minus (-) and the alarm can be stopped with the menu buttons.

Alarm sound wait time



Alarm sound delay

Use the plus (+) and minus (-) buttons to set the maximum alarm duration in minutes. The number can be 0 - 10.

NOTICE

If "Alarm sound delay" greater selected as maximum alarm time, then the display is only set to 100% brightness! No buzzer alarm!

Alarm maximum time



Alarm after time

Use plus (+) and minus (-) to set the maximum time in minutes for the alarm. The number can be 2-60.

Alarm exit



Alarm exit

With Plus (+) you exit the sub-menu alarm.

Brightness

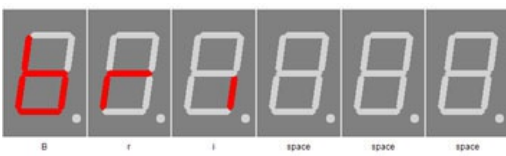

Brightness

With plus (+) you enter the sub-menu brightness.

Brightness menu



Brightness

Sets the brightness of the menu. The number can be between 10 and 25, with 10 being the darkest menu and 25 the lightest.

Brightness max

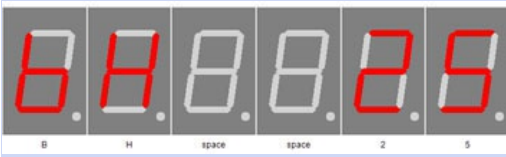

Brightness high

In this menu item, the maximum brightness plus (+) and minus (-) of the display can be adjusted.

This is also used when auto brightness is disabled.

The number can be between 0 and 25, with 0 being the darkest and 25 the lightest.

Brightness min



Brightness low

In this menu item, the minimum display brightness can be adjusted with plus (+) and minus (-).

The number can be between 0 and 25, with 0 being the darkest and 25 the lightest.

Brightness automatically



Brightness automatically on



Brightness automatically off

This allows to turn on with plus (+) and off with minus (-) the auto brightness.

Brightness speed



Brightness speed

Use plus (+) and minus (-) to set the speed of auto brightness.

The number can be between 0 and 20 and delays the brightness calculation by approx. 100 ms. With the setting 20, the brightness is therefore recalculated every 2 seconds. The maximum value may differ depending on the firmware.

Brightness factor



Brightness factor

Use plus (+) and minus (-) to set the calculation factor for auto brightness.

The number can be 1-99. There is no unit for this, as it cannot be defined due to component tolerances.

Brightness offset



Brightness offset



Brightness offset -99



Brightness offset +99

Use plus (+) and minus (-) to set the calculation offset for auto brightness. The number can be between -99 and 99. There is no unit for this, as it cannot be defined due to component tolerances.

Activate standby



StandBy (Powersave) Enable On



StandBy (Powersave) Enable Off

With plus (+) activate and minus (-) deactivate the standby mode, in this case the display is switched off or darkened. This depends on the "standby brightness". The clock and alarm function are still available, the time, date or temperature are simply not displayed.

Through the flashlight function can this interrupted.

StandBy start hour



StandBy (Powersave) Start Hour

The standby operation starts from this hour. Only full hour can be set by plus (+) and minus (-).

The range is from 0 (midnight) to 23 (11pm).

StandBy end hour



StandBy (Powersave) Finish Hour - Endstunde

From this hour on, standby operation ends. Only full hour can be set plus (+) and minus (-).

The range is from 0 (midnight) to 23 (11pm).

StandBy Brightness



StandBy (Powersave) Brightness level 1

Use plus (+) and minus (-) to adjust the brightness of the display in standby mode, 0 means off.

The range is 0 to 90, but 90 corresponds to 9 of the other brightness settings in this menu.

Exit brightness settings

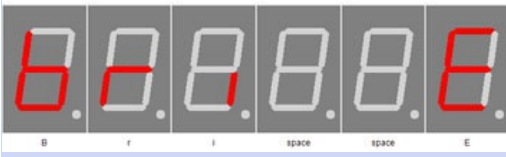

With plus (+) you exit the sub-menu brightness.

DCF

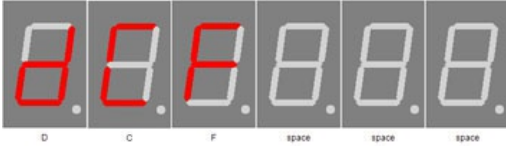

With Plus (+) you enter the sub-menu DCF.

DCF

DCF active

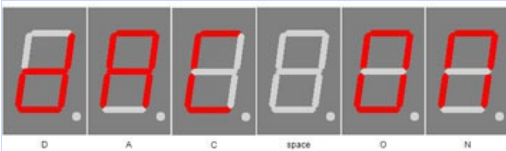

DCF active on



DCF active off

Use plus (+) and minus (-) to set whether or not DCF reception is active. If the DCF reception is deactivated, the clock only works with the built-in quartz clock. Note that in this case the time base must be set as well as possible.

Receiving brightness

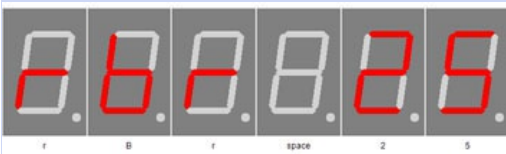

Receiving brightness

Use plus (+) and minus (-) to set the brightness during the DCF receiving. If 0, the display is turned off and the status of the synchronization is shown by decimal points. The number can be 0-25.

Hour of synchronization

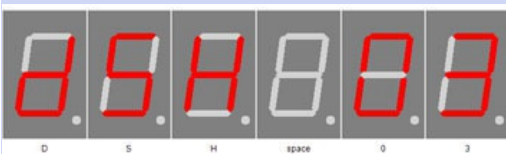

DCF synchronize hour



DCF synchronize hour disabled

Use plus (+) and minus (-) to set the hour in which the DCF clock will synchronize. In this hour, the DCF signal will be analyzed until a synchronization has occurred or the hour changes.

The number can be 0-23.

If the display shows "--" instead of a number, the synchronization hour has been deactivated and the dcf receiver is constantly trying to synchronize. In this case, the receipt display can also be displayed permanently.

Receive state display

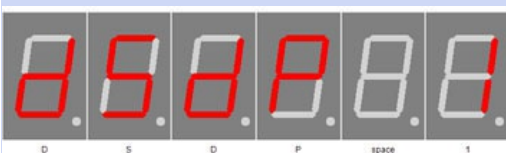

DCF status decimal point display

Use plus (+) and minus (-) to set the mode for the receive LED, which shows the received signal. The number can be 0-2.

- 0: Only until the clock has been synchronized.
- 1: Shows the received signal when the clock is not synchronized with the DCF77 signal.
- 2: During the synchronization phase, the receive signal is always on the receive LED regardless of the DCF77 synchronization flag.

Only while the clock is trying to receive the DCF signal, see "Hour of synchronization".

DCF input pull up

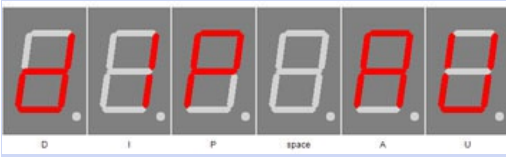

DCF input pull up auto



DCF input pull up on



DCF input pull up off

DCF77 input pin with pullup

- AU: Pull Up is automatically (default).
AU is activated by pressing the plus (+) button.
- ON: Enables the pull-up resistor
- OFF: Disables the pull-up resistor
ON and OFF is activated and toggled by the minus (-) button.
- Conrad DCF module = ON
- ELV DCF module = ON
- Pollin DCF module (3.3 V) = OFF

No guarantee for correctness of the information and changes of the manufacturer.

DCF input invert

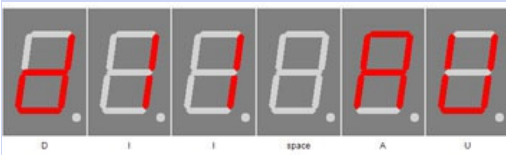

DCF input invert auto



DCF input invert on



DCF input invert off

DCF77 inverting the input pin

- AU: input is automatically inverted or not (default).
AU is activated by pressing the plus (+) button.
- ON: Input inverts
- OFF: no input inverted
ON and OFF is activated and toggled by the minus (-) button.
- Conrad DCF module = for PIN3 ON, PIN4 OFF
- ELV DCF module = ON
- Pollin DCF module (3.3 V) = OFF

No guarantee for correctness of the information and changes of the manufacturer.

If the receive LED is off every second, the setting must be inverted.

Power save pin invert

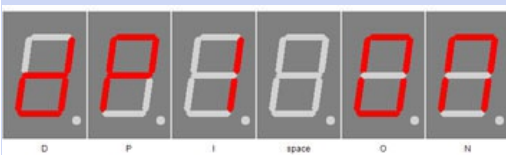

DCF powersave invert on



DCF powersave invert off

Inverts DCF77 power On / Off output, plus (+) enables inversion and minus (-) disables it:

- ON: Power ON / OFF output is inverted (module ON at GND)
- OFF: power on / off output is not inverted. (module ON at VCC)
- Conrad DCF module = No power on / off input pin available
- ELV DCF module = No power on / off input pin available
- Pollin DCF module (3.3 V) = ON

No guarantee for correctness of the information and changes of the manufacturer.

Read the instructions of the receiver module for the power on / off pin of the DCF module to set this setting correctly. Many modules do not have this pin, then this setting can be ignored.

DCF sensitivity

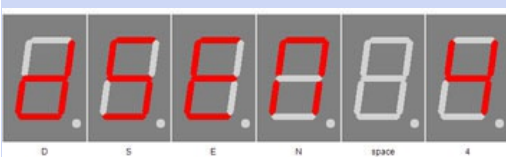

DCF sensitivity

Use plus (+) and minus (-) to set the DCF Sensitivity. 1 has a very low tolerance and 6 has the highest tolerance for reception. The Sensitivity should be set as small as possible to avoid incorrect receiving. The number can be 1-6. Tolerance means the deviation from the high and low of the time signal, i.e. 100 or 200 ms of the DCF signal.

DCF exit

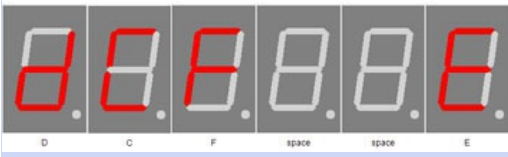

DCF Exit

With plus (+) you exit the sub-menu DCF

Clock Settings

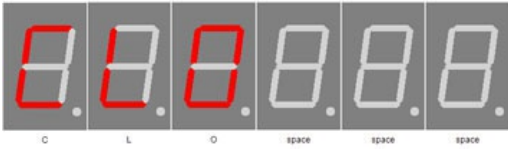

clock

With plus (+) you enter the sub-menu clock.

Set hour



change time

Use plus (+) and minus (-) to set the hour.
The number can be 0-23.

Set minute



change time

Use plus (+) and minus (-) to set the minute.
The number can be 0-59.

Set year

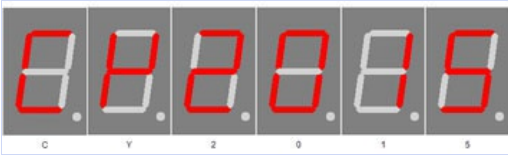

change year

Use plus (+) and minus (-) to set the year.
The number can be 2000-2099.

Set month



change month

Use plus (+) and minus (-) to set the month.
The number can be 1-12.

Set day

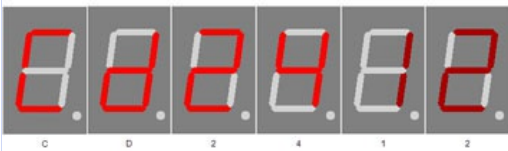

change day

Use plus (+) and minus (-) to set the day, limit by month.
The number can be 1- 28, 29, 30, 31.

Day of week



Monday - Montag



Tuesday - Dienstag

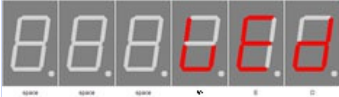

Wednesday - Mittwoch



Thursday - Donnerstag

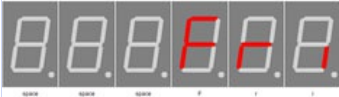

Friday - Freitag



Saturday - Samstag



Displays the day of the week from the set date.

Set time

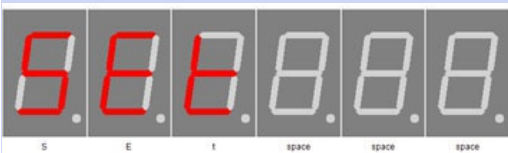

Set settings

Plus (+) sets the time, while looking for DCF time, otherwise the time will be provided directly.

Calibrate quartz



Calibrate quartz +10



Calibrate quartz -10

With plus (+) and minus (-) the quartz can be calibrated, a positive value increases the period time and a negative value reduces it. The period should also be set as precisely as possible to 1ms or 1kHz (for frequency measurement). The measurement must be carried out on pin TB. Further information can be found in the chapter [Quartz properties - Accuracy of the time](#)".

Exit clock settings

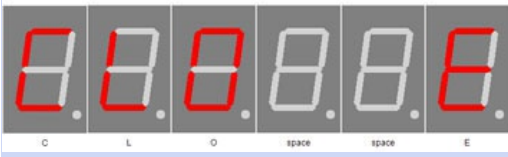

Clock end

With plus (+) you exit the sub-menu clock. Until here the clock, without DCF synchronization, will be taken and used until the next scheduled synchronization.

Info section

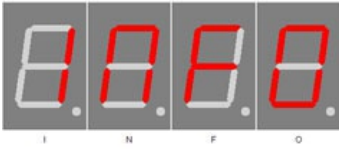

This indicates the start the information area

IC number

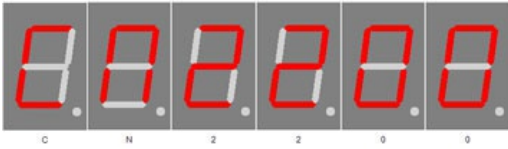

Chip number

IC / device type

Firmware version



Firmware version

Firmware version

Example, it might be something else at this point.

Menu end

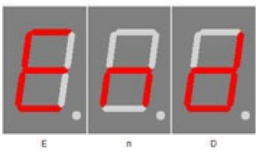

End

End of the menu, hide automatically after 2 seconds.

Attachment

Bootloader handling

Start the IC/module/device in bootloader mode

1. Switch off the IC/module/device.
2. Connect the UART adapter (USB → 3.3 volts or 5 volts UART or RS232 → 3.3 volts or 5 volts UART).
"DCF in" → UART adapter TXD and "DCF ps" → UART adapter RXD.
3. Press the button S1, power up the IC/module/device with voltage and do not release this button until you hear a short BEEP. The display is off.
4. Now you can connect to the firmware upload tool.



Wrong UART level

If an incorrect voltage level (for example directly RS232, ± 12 Volt) is used, the UART adapter or the IC/module/device can be damaged or destroyed. In the worst case, overheating and fire may occur!

NOTICE

Defect firmware

Defect firmware can be detected as follows: Every second a short BEEP.

Use the Firmware Upload Tool to upload an update

1. Download the latest upload tool from www.stefpro.biz: [SP Firmware UP](#)
2. Start the tool
3. Select the COM port.
4. Press the "Load" button and select a firmware which you have previously downloaded from SP Firmware UP
5. Now press the "Connect" button, the data from the IC / Module / device will be read and the compatibility of the new firmware with the IC / module / device will be checked
6. If an upload is possible, you can now press the "Upload Firmware" button. The upload starts and should not be interrupted.

NOTICE

Firmware upload interruption

If the firmware upload is interrupted or uploaded an inappropriate firmware, so there is a broken firmware, the IC can be operated only in bootloader mode.

7 segment characters

The symbolism of each character:

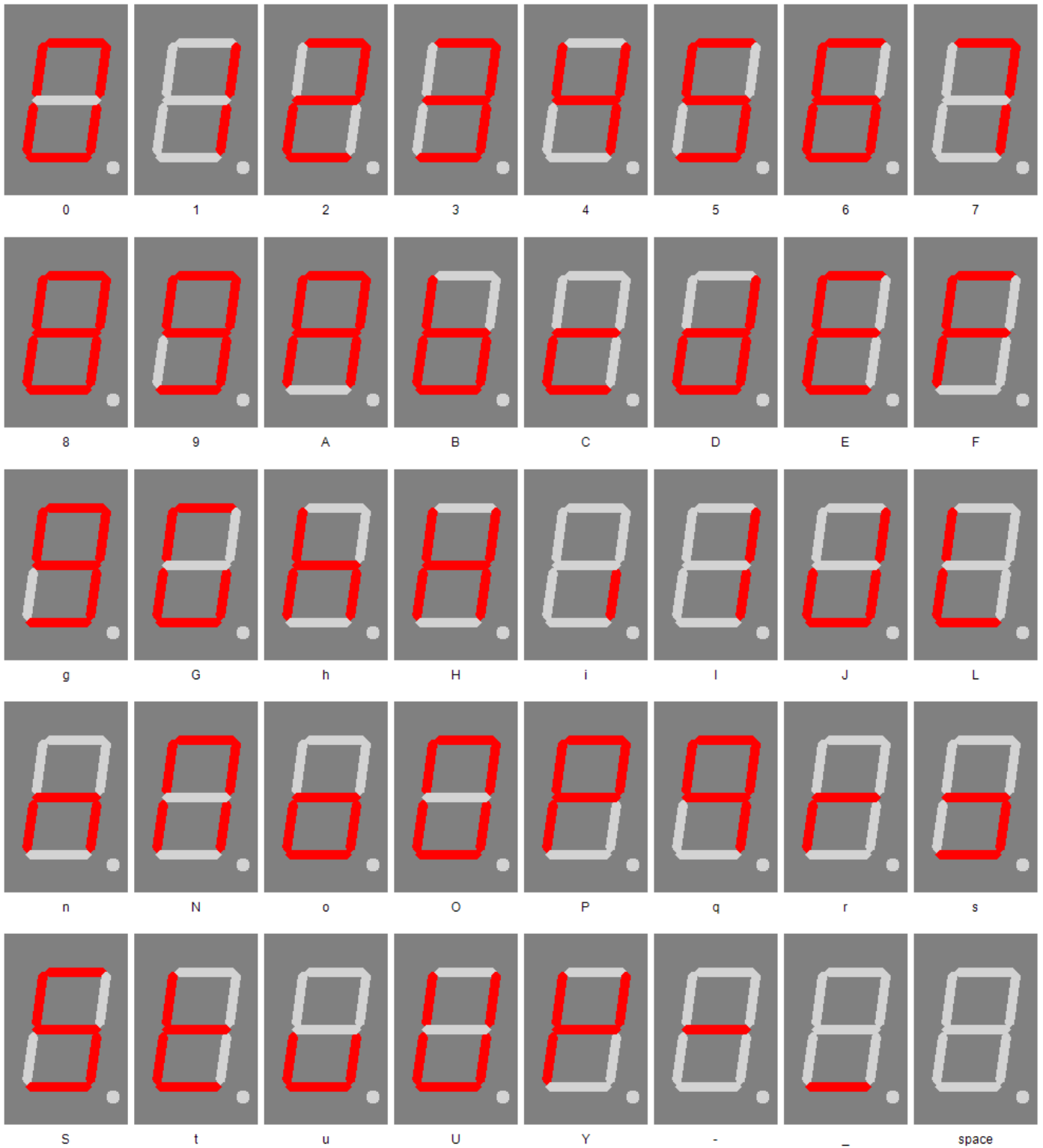

Change log

Safety

20.03.2017 - 1.0.3 - ADD
Add ESD note

Product overview

05.07.2017 - 1.0.5 - ADD
Add Product overview
29.12.2021 - 2.0.1 - ADD
Add new family SPMx22nn

Quartz properties- Accuracy of the time

12.06.2020 - 2.0.0 - ADD

DCF module properties

21.11.2016 - 1.0.1 - ADD
Add list of tested modules
20.03.2017 - 1.0.3 - ADD
Update list of tested modules, add standard pin assingment

Power supply properties

21.12.2019 - 1.0.5 - ADD
Add SNT description

Buzzer to MP3 player

09.12.2016 - 1.0.2 - ADD
Add buzzer to mp3 player change description

Set day

23.04.2017 - 1.0.4 - ERROR
Bugfix wrong title, this sets the day not the month.

Liability, warranty and copyright notice

Definitions

- "Programmed IC": IC which was developed by StefPro and can only used with a minimum basic circuit.
- "Manufacturer of the whole device": The manufacturer of the whole device, the natural or legal person is mounted a device which can be made to function without special knowledge. E.G. Simple connection to the network via a euro, safety plug or by connecting to a power supply.

Liability

- Although the information contained in this document has been checked very carefully for accuracy and completeness, for errors and omissions can not be held liable. StefPro reserves the right to any time change any portion of the described hardware and software features.
- StefPro delivers only the "programmed IC", a basic circuit and possibly an [example circuit](#), but these are not tested for CE and EMC. The "Manufacturer of the whole device" requires the valid VDE, CE and EMC is comply with regulations.
- There is no liability for damages incurred directly by or in the application of the "programmed IC", as well as for damage caused by chemical or electrochemical effects of water or generally from abnormal environmental conditions.
- "Programmed IC's" by StefPro may not be used in critical equipment. At disregard exclusively the responsibility of "Manufacturer of the whole device."

These include:

- medical devices for implanting or life obtained.
 - Critical equipment for space, aerospace and traffic.
 - Other important life components or systems, where an error is fatal.
- All developed with a "programmed IC" by StefPro modules and devices must be the responsibility of the "Manufacturer of the whole device" sufficiently tested to detect any defects.

Warranty

- StefPro warranty only for the programmed IC and their firmware. The warranty is exclusively limited for the replacement of the IC within the warranty period for obvious defects in the hardware, and programming error.
- Warranty does not extend the warranty period or starts a new period again.
- Additional or deviating claims are excluded, especially claims for damages arising out of the product for damage. This will not affect claims based on inalienable rules under the product liability law.

Copyright notice

The circuitry and firmware from StefPro is protected by copyright.. Unauthorized reproduction or distribution of programmed IC's with this program or any portion of it. This is pursued both criminal and civil law, and may result in severe penalties and compensation for damages.

Disposal information

Do not dispose devices in household garbage!

This modules or devices comply with the EU directive on electronic and electrical equipment (WEEE regulation) and therefore may not be disposed of with household waste. Dispose of the device over your local collection center for electronic equipment!



WEEE-Reg.-Nr.:

DE 58929072 (StefPro UG (haftungsbeschränkt) & Co. KG)

DE 78089358 (StefPro Einzelunternehmen bis zum 01.01.2015)

Impress

StefPro™ UG (haftungsbeschränkt) & Co. KG
- Softwareentwicklung für Prozessoren

Dipl. Ing. (FH) Stefan Nannen

Theilenmoorstr. 11

26345 Bockhorn – Germany

Phone: +49-4452-709175 (please note our [business hours](#))

Web:<http://www.stefpro.biz/>

E-mail: info@stefpro.biz