

SPK2121.01

Assembly kit - Six digit dcf clock

for small weaker display, with temperature display

Assembly plan for the kit

Version: Firmware 1.82-148

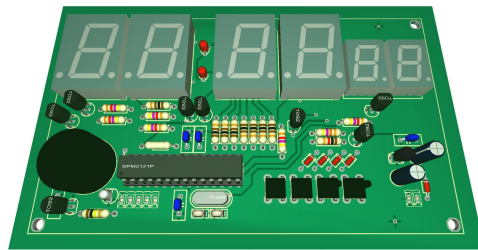

StefPro UG (haftungsbeschränkt) & Co. KG
Theilenmoorstr. 11
26345 Bockhorn, Germany

Phone: +49-4452-709175
Web: <https://www.stefpro.biz/>
E-mail: info@stefpro.biz

Assembly plan version 2.0.1 - Valid from 22.03.2021.

Table of Contents

Table of Contents	2
Safety	4
Application and function description	5
Function description	5
Alarm Function	5
Technical data	5
Bill of material	7
Basic assembly	8
Connectors	12
X-DC : DC Power input : Print plug 2 pole	12
X-DCF : DCF input, DCF PowerSave output: Print connector 5 pin	12
Properties of the components	14
7 segment displays	14
Possible displays	14
Calculate the series resistor for one LED	15
Calculate the series resistor for two LED	15
DCF module properties	16
Tested modules	16
Our standard color coding for DCF signals	16
Connection of the DCF module using a fake module	17
Without Power On / Off or Power Save input	17
With Power On / Off or Power Save input	18
Power supply properties	18
Quartz - Accuracy of the time	19
Buzzer to MP3 player	19
Properties of light sensor with Phototransistor	20
Temperature sensor	21
Method of calibration with a temperature value	21
Procedure for calibration with an offset value	21
Installation the DCF clock	23
Synchronize with active display	23
Synchronize with deactivated display	23
Emitted electrical disturbances by the display	25
Test setup	25
Measurement results	25
Button description	27
Overview of buttons	27
Button functions	27
General key functions	27
Menu	27
Normal	28
Display mode of clock	28
Show Temperature	29
Alarm	29
Alarm enable	29
Alarm time hour	29
Alarm time minute	29
Alarm snooze time	30
Alarm sound wait time	30
Alarm maximum time	30
Alarm exit	30
Brightness	30
Brightness menu	30
Brightness max	31
Brightness min	31
Brightness automatically	31
Brightness speed	31
Brightness factor	31
Brightness offset	32
Activate standby	32
StandBy start hour	32
StandBy end hour	32
StandBy Brightness	32
Exit brightness settings	33

DCF	33
DCF active	33
Receiving brightness	33
Hour of synchronization	33
Receive state display	33
DCF input pull up	34
DCF input invert	34
Power save pin invert	34
DCF sensitivity	34
DCF exit	35
Clock Settings	35
Set hour	35
Set minute	35
Set year	35
Set month	35
Set day	36
Day of week	36
Set time	36
Calibrate quartz	37
Exit clock settings	37
Info section	37
IC number	37
Firmware version	37
Menu end	37
Attachment	38
Bootloader handling	38
Start the IC/module/device in bootloader mode	38
Use the Firmware Upload Tool to upload an update	38
7 segment characters	39
Change log	39
Safety	39
DCF module properties	39
Power supply properties	40
Buzzer to MP3 player	40
Temperature sensor	40
Set day	40
Liability, warranty and copyright notice	41
Definitions	41
Liability	41
Safety Notes	41
Intended operation	41
Warranty	41
Copyrightnotice	42
Disposal information	43
Impress	43

Safety

Follow the manual



This assembly kit is only safe in operation if all instructions are read in this datasheet.

The assembled kit is called in the following module.





General understanding of safety

By the module there are no hazard under normal use.

Intended Use



The module is designed for driving small to middle displays.

Concealed Hazards

-   When handling tools such as side cutter, pliers and soldering iron there is a risk of injury. Look for a safe handling and do not touch the hot soldering iron or just heated solder joints.
-  The pins of the components are very pointed and sharp! Therefore, this may cause in sores in case of incorrect handling.
-  The pins of the components can be pointed and sharp even after installation! Therefore, this may cause in sores in case of incorrect handling.
-  Spalling of parts on reverse polarity or overloading of the module.







Wear during the initial commissioning eye protection.

-  If the buzzer emits more than 90 dB, it may cause hearing loss over a long period of time. The circuit board is intended for installation in a housing, thereby lowering the level of the buzzer used.
-  Use always passing a ESD bracelet to avoid electric charges! The module can be damaged if handling without an earthing tape and housing! The power should come from a safe transformer (also protected transformer) or a corresponding low voltage power supply for the circuit. Never use a higher voltage or direct mains voltage!



DANGER

following hazards may arise in case of wrong construction of the circuit and wrong handling of module:

-  With the direct connection to mains, it's a dangerous voltage on the module and other components, use a safety transformer!
-  Reverse polarity and overloading the module may cause in smoke. This smoke possibly contains toxic substances which must not be inhaled! Ventilate the room.
-   Reverse polarity or overload of the module can cause a hot surface on the IC or other component in the circuit.
 - There is a risk of burning when touching.
 - And flammable materials, for example Paper, can come in fire.

Modifications of the example circuit

The successfully built device may be damaged. Therefore check as appropriate all housing part and lines for damage. This applies in particular to parts of the directly (for example power cord and power supply) or indirectly come into contact with mains voltage.

Application and function description

Function description

This IC can analyze the DCF77 signal, which is received by a receiver and demodulated. The received time and date can output directly to a 7-segment displays. The clock synchronizes itself automatically once a day. The hour of the synchronization can be set in the menu.

The time is displayed according to DIN 5008, which means a leading 0 at the hour. 8 a.m. looks like 08:00:00 and 8 p.m. 20:00:00

Due to the 6-digit display, the date is not shown according to DIN 5008. The 24 December 2020 looks on the display like 24.12.20.

The DCF77 signal is a low frequency radio signal which transferred the time and date. It will be sent in Frankfurt am Main, derived of the local atomic clock and sent with the carrier frequency of 77.5 kHz. Therefore, these watches are also known as radio clock.

The input for the DCF77 antenna can now automatically detect whether a pullup resistor is required and whether the input has to be inverted.

Even a simple alarm function is implemented.

This IC has the new **OnChip HalfMultiPlex Display technology**. With this technology also small darker displays can work and the displays are generally brighter.

This IC also has an adjustable brightness control for the display, thereby the display is easy to read during the day and at night it does not light out the entire room.

With this IC the **temperature** will be displayed alternately with the time and or date.

This IC has a bootloader, which allows you to update the IC firmware. This means that you will always remain at the current state of the Firmware for the IC, without further costs.

Alarm Function

The simple alarm clock function allows you to set one alarm time so that you are wake up every morning.

In the menu the alarm and the snooze time can be set. With the adjusted snooze time the alarm waits if the alarm is not stopped at a wake-up call, but the snooze function is activated. The maximum alarm time can be adjusted between 2 and 60 minutes.

The alarm can be activated and deactivated also outside the menu. If the wake-up call is active with S1 or S2 the alarm clock can be stopped and with S3 or S4 the snooze function will be activated.



Dissembled time

Because the DCF clock daily synchronized with the current DCF time, it is possible that in worst cases, an incorrect time is read and therefore the wake-up call comes at a wrong time! Therefore, the time synchronization should eventually be placed in a time of day where it is possible to check the correct time before sleeping, if the alarm function is used.

Technical data

- Operating voltage: 9 - 12 volts DC
- Current: 200mA
- Power: approximately 1.8 W (at 9 volts)
- Volume level of the buzzer: approx. 85 to 90 DB
- Accuracy of the timer: better uncalibrated 99.999.9 %; calibrated better 99.99999.999 %
- Temperature accuracy:
 - Worst inaccuracy: ± 2.5 °C
 - Typical: ± 1 °C
 - Calibrated: $< \pm 1$ °C

The values apply when using the LM35, when calibrated, the value can also be reached for other sensors.

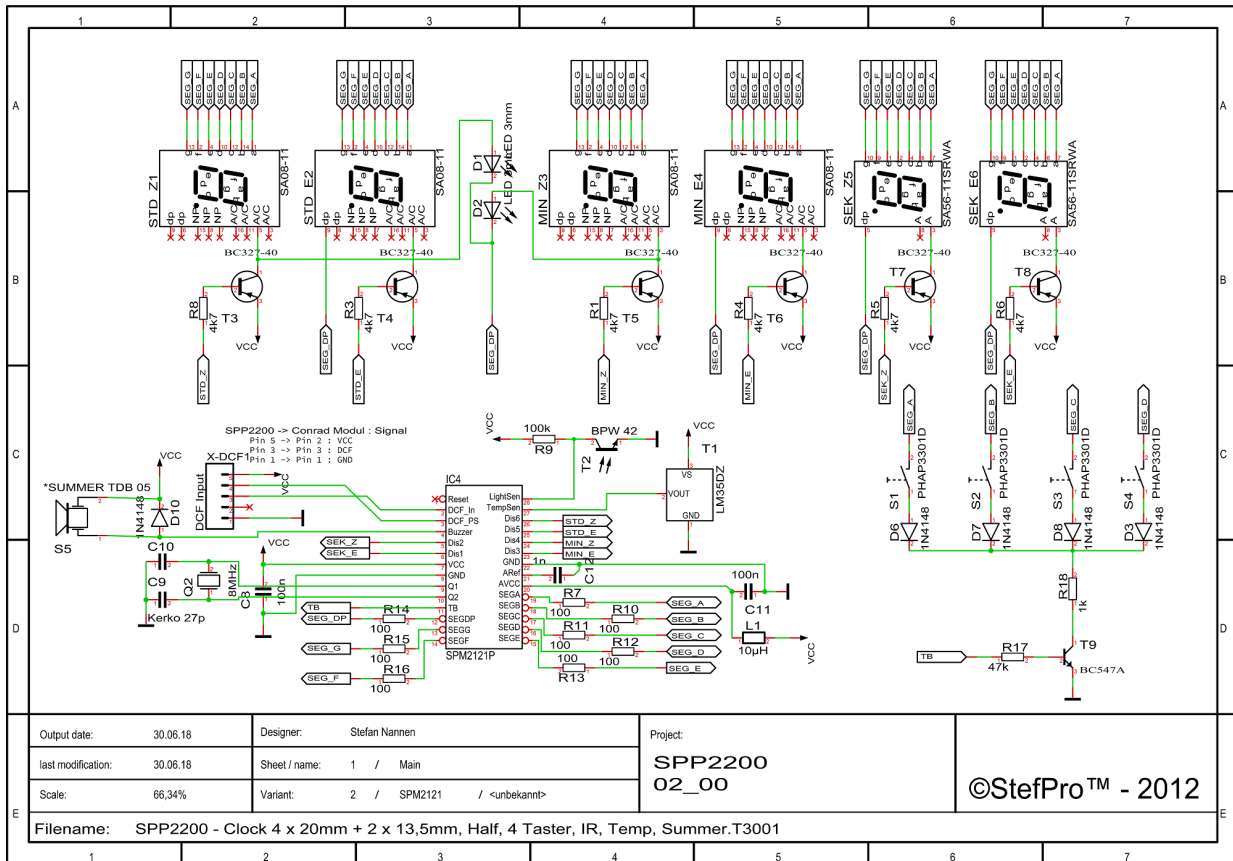

Figure 1: Basic circuit of SPK2121.01 part 1

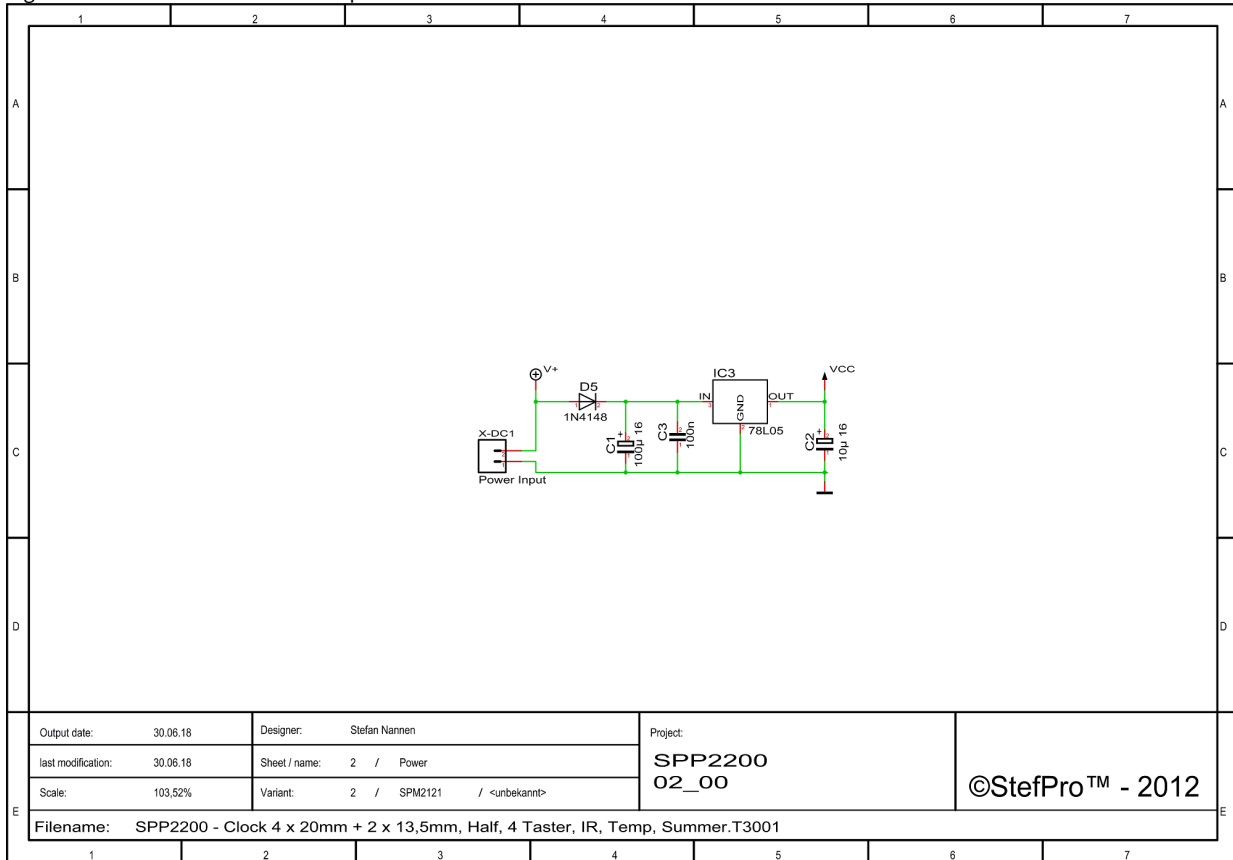

Figure 2: Basic circuit of SPK2121.01 part 2

Bill of material

Pos	Quantity	Name	Value	Package
Scope of delivery				
1	6	D3,D6,D5,D7,D8,D10	1N4148	D3
2	6	R1,R3,R4,R5,R6,R8	4k7 1/4	0207
3	8	R7,R10,R11,R12,R13,R14,R15,R16	100 1/4	0207
4	1	R9	100k 1/4	0207
5	1	R17	47k 1/4	0207
6	1	R18	1k 1/4	0207
7	6	R1,R3,R4,R5,R6,R8	4k7 1/4	0207
8	1	L1	10µH	R-1016
9	4	C3,C4,C8,C11	100n	C2
10	2	C9,C10	Kerko 27p	C1
11	1	C12	1n	C2
12	1	Q2	8MHz	HC49/U
13	1	IC3	78L05	TO92
14	1	IC4	IC-Sockel 28 Small	DIL28/S
15	1	T1	LM35DZ	TO92
16	1	T2	BPW 42	FOTO_5MM
17	6	T3,T4,T5,T6,T7,T8	BC327-40	TO92
18	1	T9	BC547A	TO92
19	1	S5	Buzzer TDB 05	D18R7,62
20	1	C1	100µ 16	ELKO1
21	1	C2	10µ 16	ELKO1
22	4	S1,S2,S3,S4	PHAP3301D	KURZHUBTASTER_6X6
23	1	IC4	SPM2121P or SPM2221P	DIL28/S
24	1		SPP2200	PCB
To order separately				
25	2	D1,D2	LED 3mm	LED_3MM
26	4	STD_Z1,STD_E2,MIN_Z3,MIN_E4	SA08	S_08
27	2	SEK_Z5,SEK_E6	SA56	S_56
28	1	X-DC1		
29	1	X-DCF1		

Basic assembly

The basics of electronics and PCB assembly can be found in the document: "[Grundlagen der Elektrotechnik, Grundlagen des bestückens von Platinen](#)". Unfortunately currently only available in German.

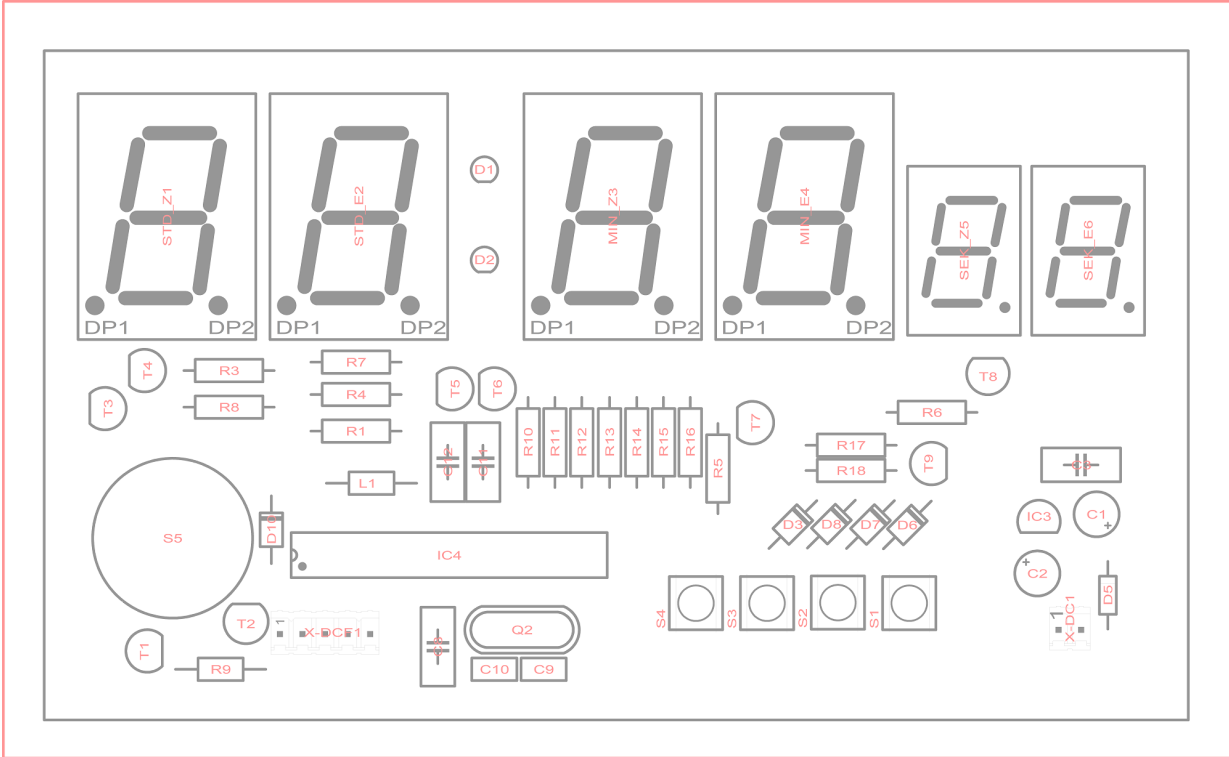

Figure 3: Basic assembly of SPK2121.01
Assembly plan with names

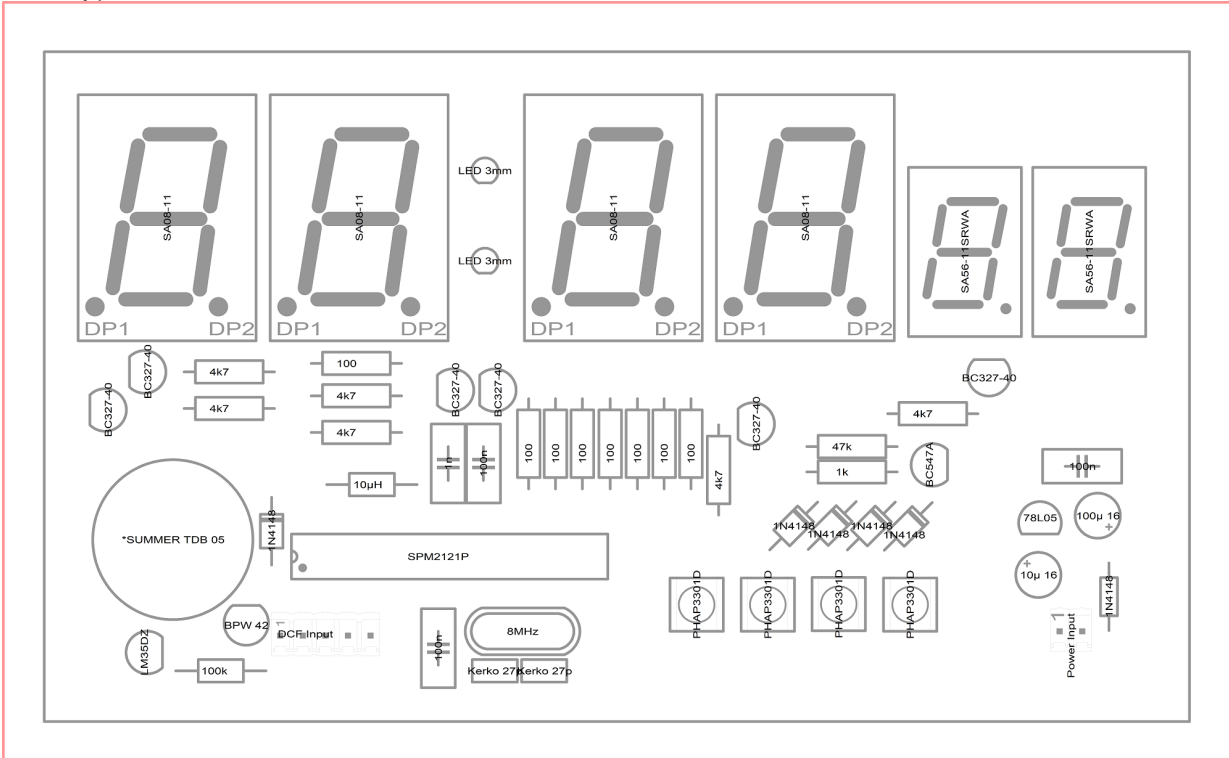

Figure 4: Basic assembly of SPK2121.01 1
Assembly plan with values

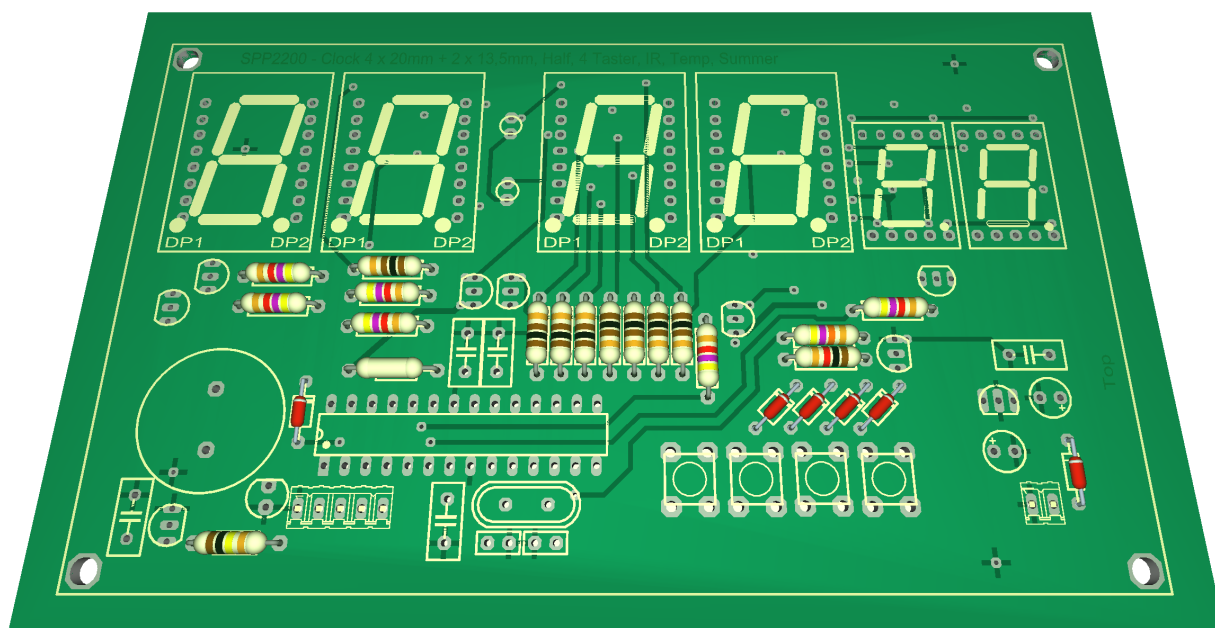

Figure 5: Basic assembly of SPK2121.01 step 1

First, solder flat components, such as resistors, diodes and coils. Attention: the coil L1 is shown wrong, this is [brown, black, black, silver].

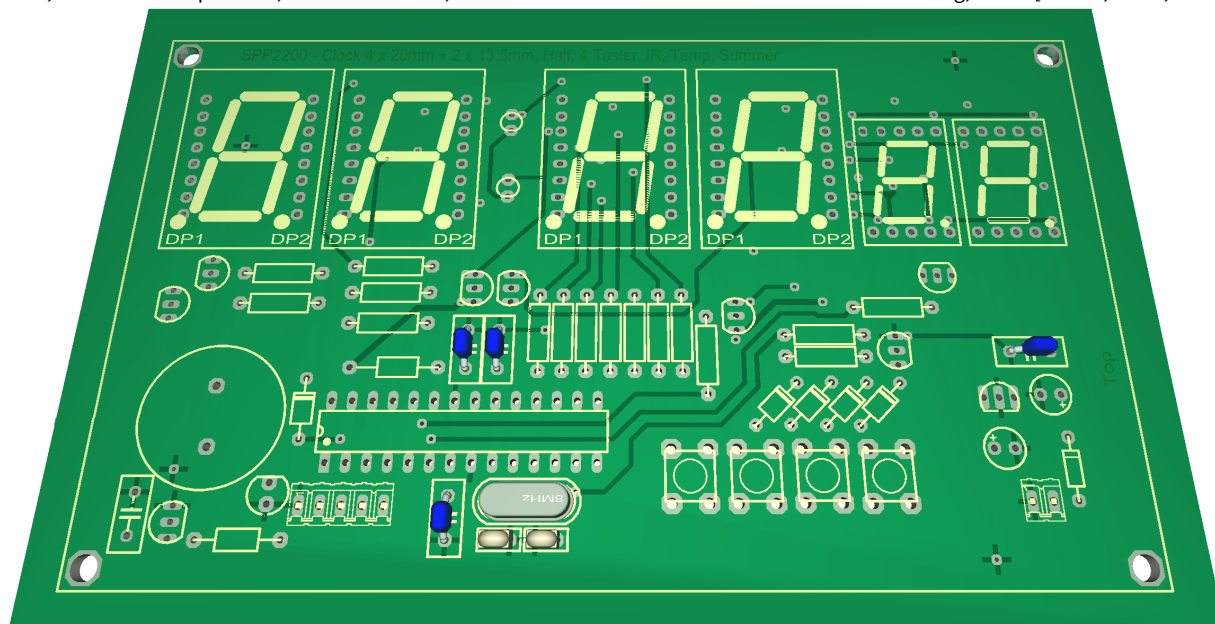

Figure 6: Basic assembly of SPK2121.01 step 2

Now you can solder ceramic capacitors and the quartz.

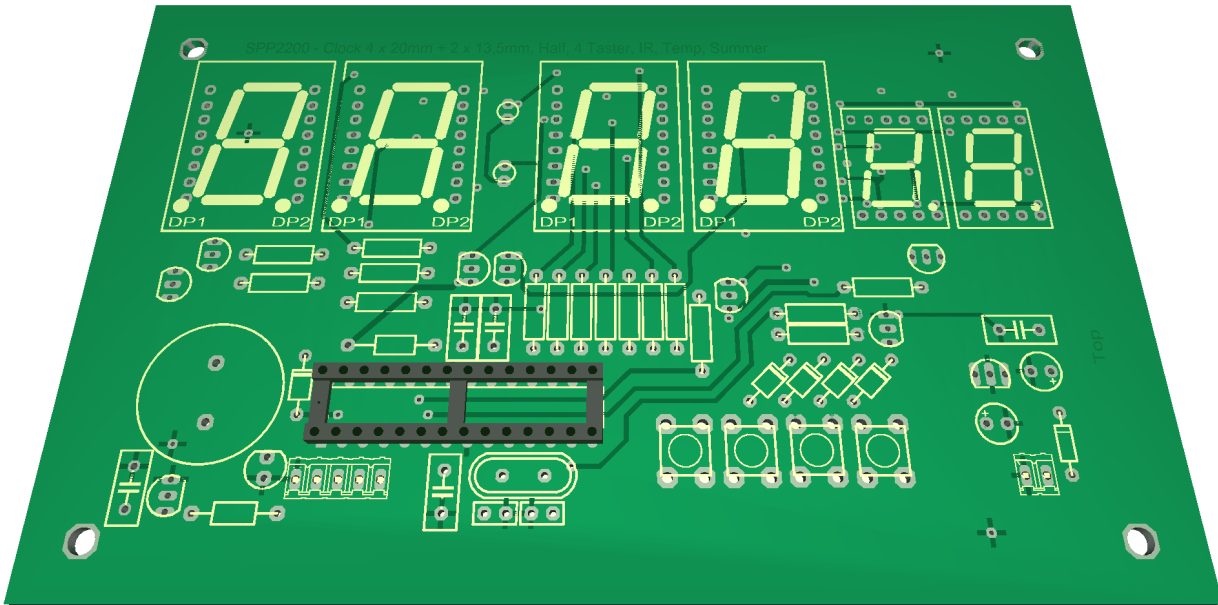

Figure 7: Basic assembly of SPK2121.01 step 3

Now comes the IC socket for the SPM2121P. The IC SPM2121P can also be soldered directly, but should not.

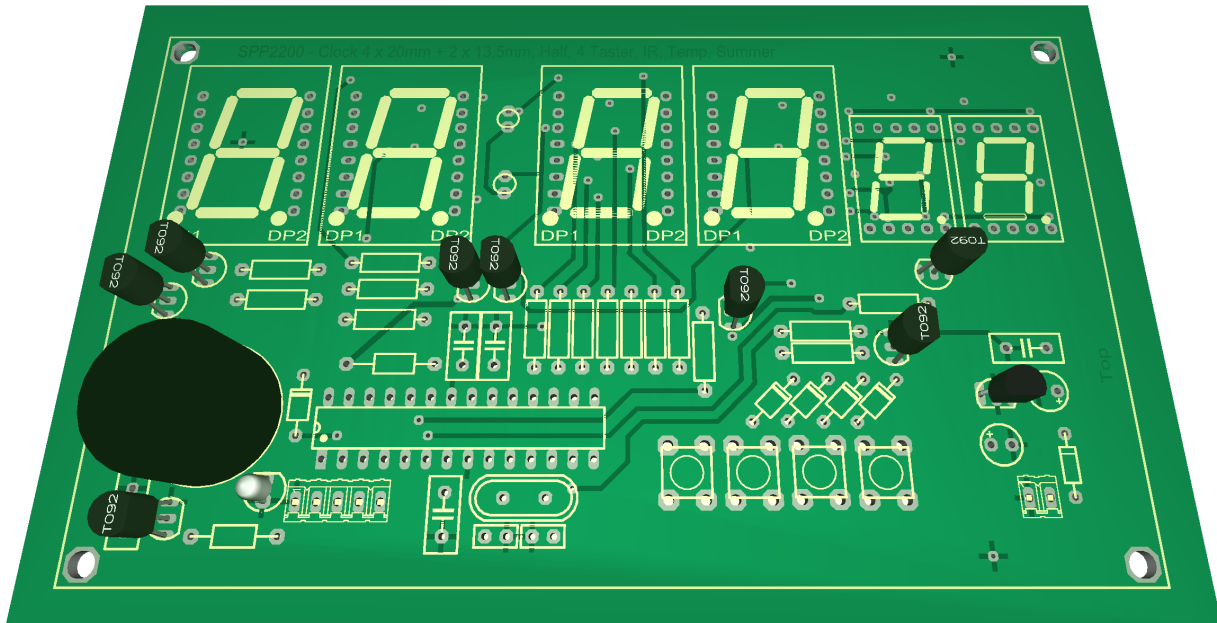

Figure 8: Basic assembly of SPK2121.01 step 4

Now it's time for the transistors and TO92 IC's, be sure to leave a little space to the PCB. This also applies to the BPW42. Optionally, the temperature sensor can be connected via stranded wire to achieve better heat coupling to the housing, in this case use shrink tubing for insulation. The buzzer can now also be soldered.

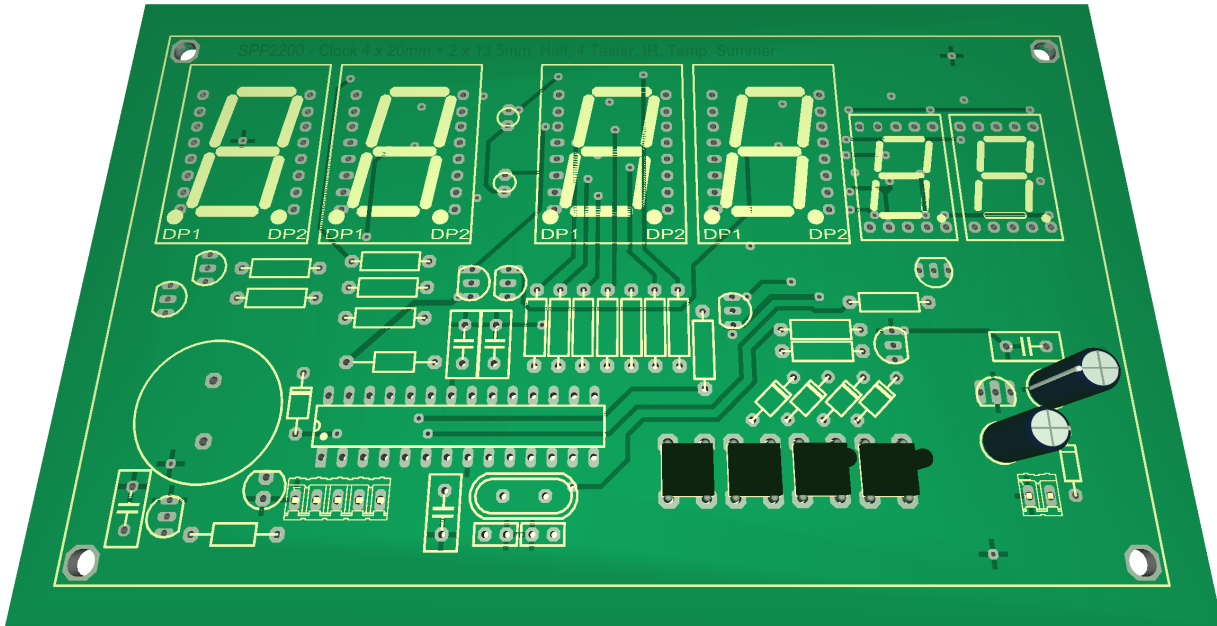

Figure 9: Basic assembly of SPK2121.01 step 5
The buttons and Elko's are a bit higher and are therefore now their turn.

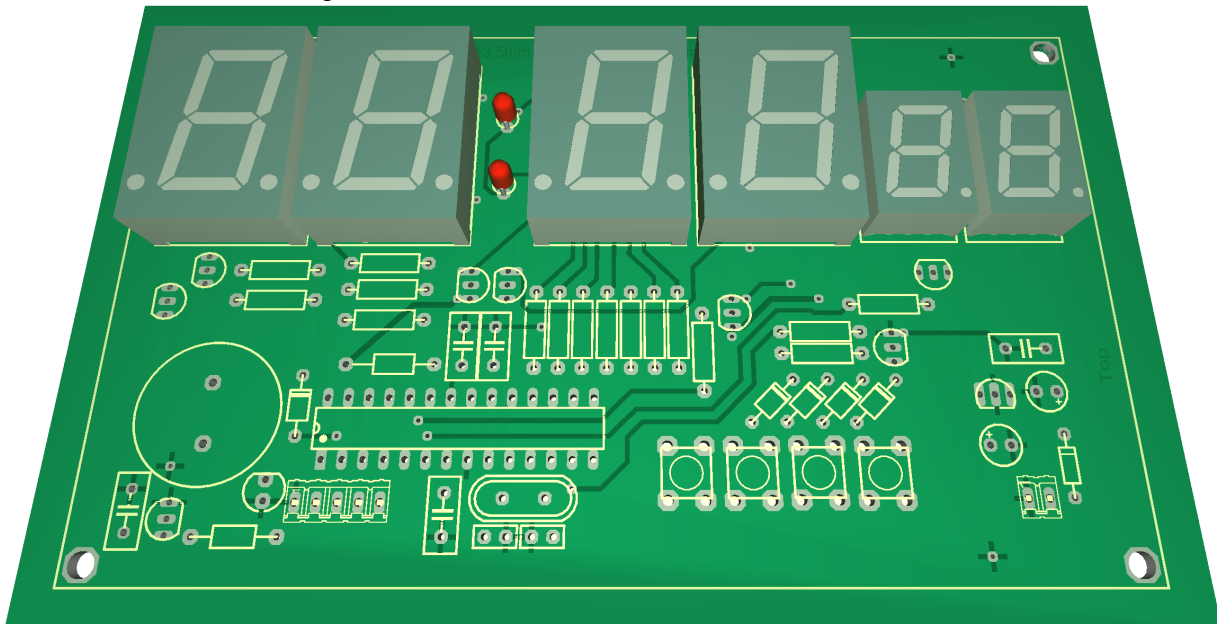

Figure 10: Basic assembly of SPK2121.01 step 6
Finally, the LEDs and 7 segment displays (these are to be ordered separately), these are to be soldered directly onto the PCB.

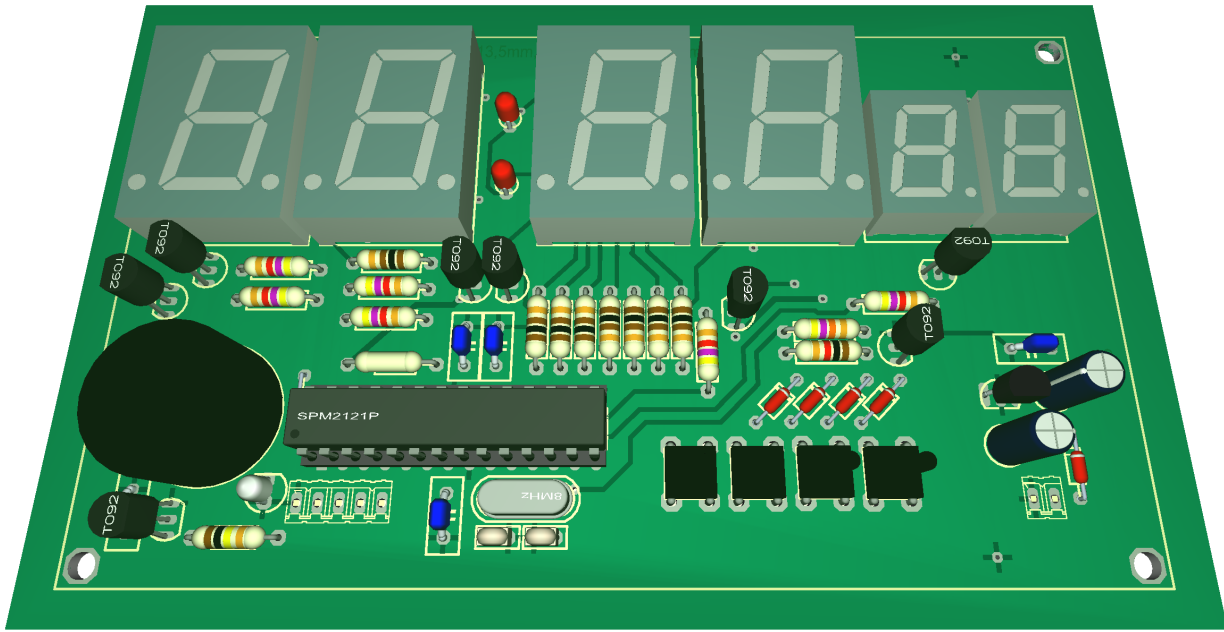

Figure 11: Basic assembly of SPK2121.01 step 7
The finally assembled pcb, only the wires for the supply voltage and the DCF receiver are missing.

Connectors

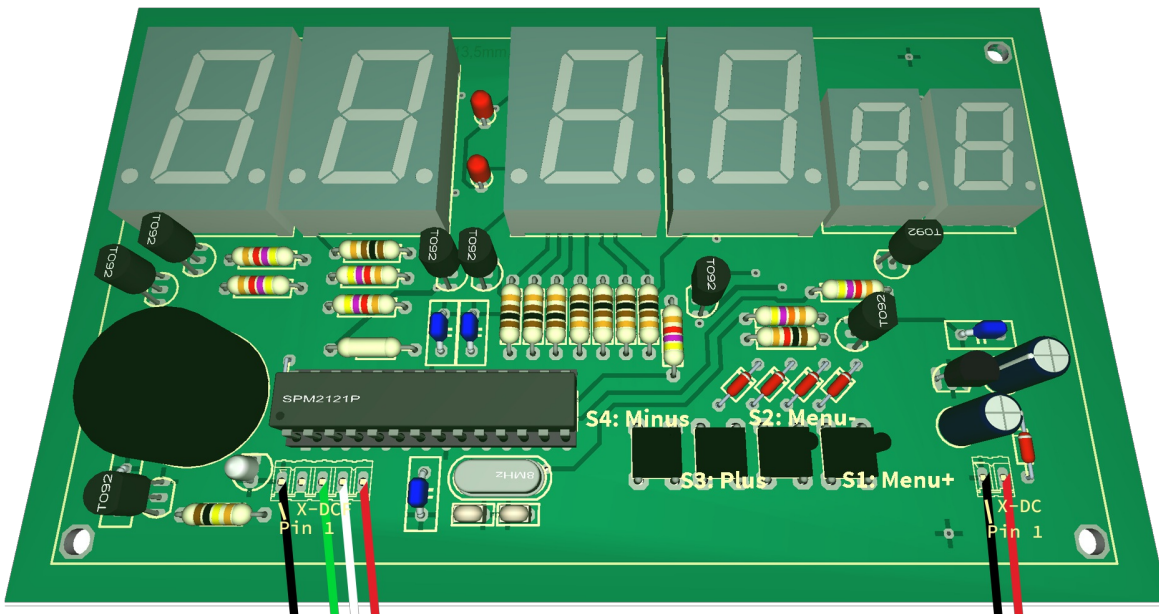

Figure 12: Connector description for module SPP2200.0

Here, the leads are soldered directly to the pins on the circuit board. You can solder them from the front or the back.

DANGER

Make sure that you have connected all signals correctly. There is no overload and polarity protection!

X-DC : DC Power input : Print plug 2 pole

Pin	Name	Direction	Function	Maximum
1	GND	Power		
2	V+	Power	Power supply input of the module	9 - 12 volts DC, 200mA

X-DCF : DCF input, DCF PowerSave output: Print connector 5 pin

Pin	Name	Direction	Function	Maximum
1	GND	Power		

2	N.C.		Do not connect	VCC
3	DCF in	Digital input	<u>DCF signal input</u>	VCC
4	DCF ps	Digital Output	<u>DCF PowerSave output</u>	VCC
5	VCC	Power		5 volts DC, 30mA

Never solder the DCF module directly onto the circuit board, even if the ELV module suggests it. Please connect this with some stranded wire to allow a certain distance to the display.

Please also note the information in the chapter "Properties of the components - DCF module properties".

Properties of the components

7 segment displays

The seven-segment display LD1 must have a common anode. The anode is driven by a transistor which must withstand at least 100 mA on the CE track. Via R1, the brightness of the LEDs of each display can be adjusted in limits. It should be noted that with direct control by SPK2121.01 the maximum current in SEG_A SEG_DP is 20 mA. R2 to R9 are the LED resistors, these are for example a 6 digit display used just once. The resistors are connected to

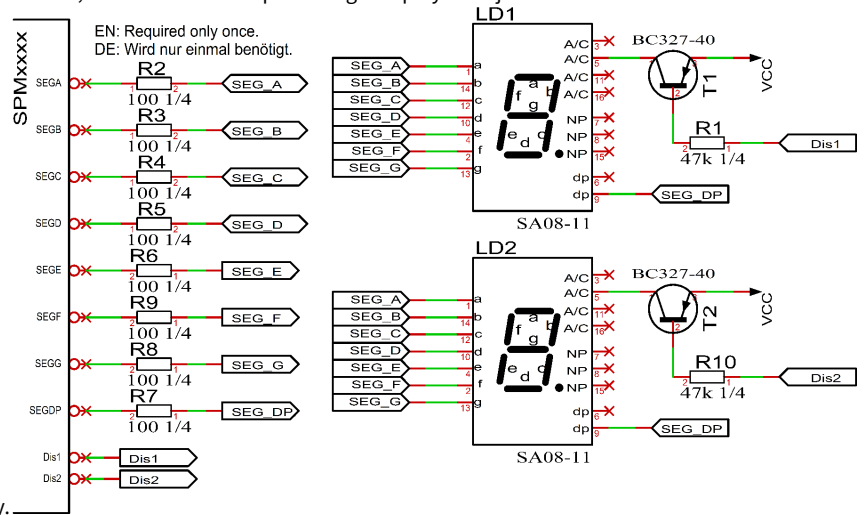

the IC. The other displays are to be wired in the same way.

Possible displays

For big displays SA08-11SRWA in red, SA08-11YWA in yellow, SA08-11PBWA in blue and for small displays SA52-11SRWA in red, SA52-11YWA in yellow, SA52-11PBWA in blue by Kingbright. Others on request.

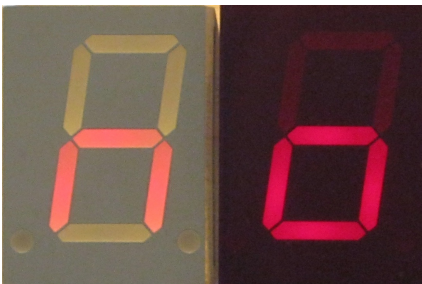

Figure 15: SA08-11SRWA left without and right with contrast pane with back light.



Figure 16: SA08-11SRWA left without and right with contrast pane without back light.

Below with and above without back light.

Because the displays are half multiplexed (only four LEDs are lights at the same time for a maximum of 30microseconds) to minimize component count and power consumption, not all 7-segment displays are usable.

Also note, that the displays which can work with 10 mA constant current, not implicitly work with 10 mA pulsed current. All displays have been limited with a 100 ohm resistor.

The brightness of the display is designed for the brightness conditions in a living room or laboratory. Since the circuit is optimized for minimum components and power consumption, the readability is limited with direct irradiation by spotlight or sunlight without a contrast panel very limited and with better.

It is recommended to place a contrast glass in the corresponding display colour in front of the displays, see figure 16 and 15.

Correct colour of the glass.

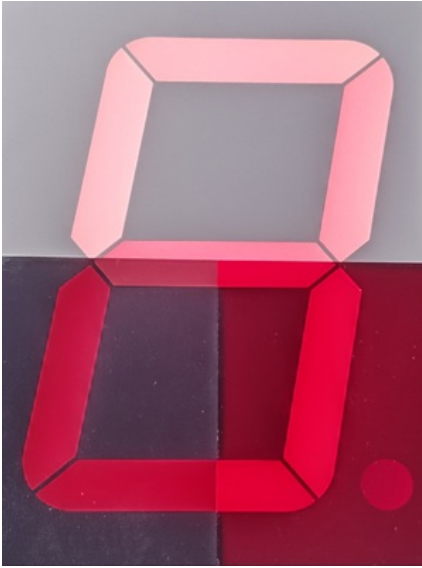

Figure 17: SA40-19SRWA top without, bottom left grey and right with red contrast lens with front light

SPI contrast without front light 2

Figure 18: SA40-19SRWA upper red and lower gray contrast pane with front light.

The colour of the disc also makes a difference, see 17 and 18 with 20,000 lux front light. Note: The menu is always displayed with 100% brightness.

Calculate the series resistor for one LED

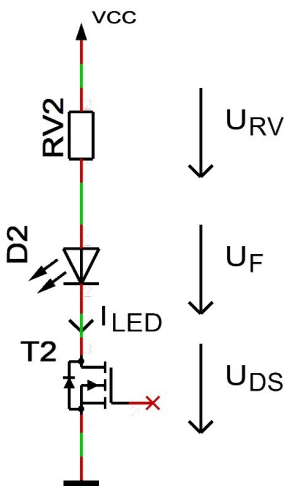

$$RV2 = \frac{VCC - U_F - U_{DS}}{I_{LED}}$$

- $U_{DS} \approx 0$
- $I_{LED} < 35 \text{ mA}$

Calculate the series resistor for two LED

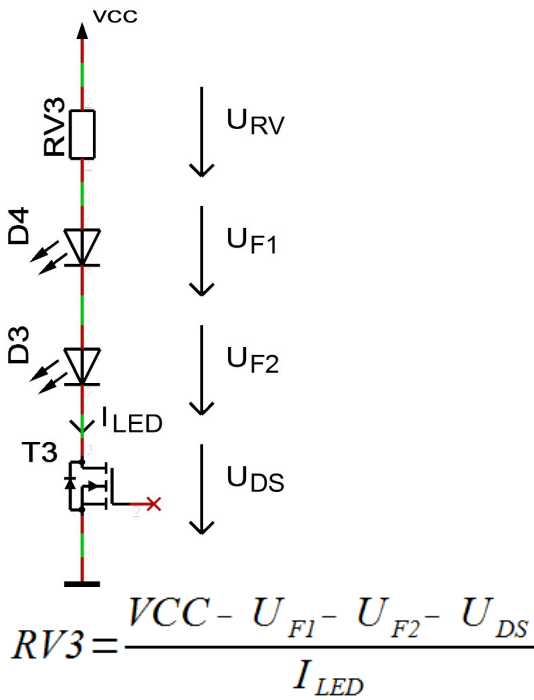

- $U_{DS} \approx 0$
- $I_{LED} < 35 \text{ mA}$

DCF module properties

- The module has to be able to work with an operating voltage of 5V (some modules have an operating voltage range of 1.2 to 15 volts, these are also usable)
- The output has to be able to drive a CMOS input with a input impedance of 10kO
- For DCF modules with open collector (open collector) or open drain output the input detected automatically by default whether a pull-up resistor is required. In menu a pull-up resistor can be connected or disconnected permanently.
- Polarity of the output:
 - The output has to be non inverting, the high state has to be 100ms or 200ms
 - The output has to be inverting, the low state has to be 100ms or 200ms
 - The receiving LED should at good reception signal flash every second for 100 ms and 200 ms. Does the receiving LED goes off every second for 100 ms and 200 ms, then the polarity is wrong. Unfortunately, you then connected a wrong module, this can't be analyzed with the microcontroller.
 - Whether the output is non inverting or inverting, is detected automatically by default or can be set in the menu.
 - The receiving LED should at good reception signal flash every second for 100 ms and 200 ms. Does the receiving LED goes off every second for 100 ms and 200 ms, then the polarity is wrong. To correct this, you has to be invert the setting for the inverting DCF input pin in the menu. (Instead of on → off → on or off)
- The DCF module can have a power on / off pin. Then the DCF module is automatically switched off when the DCF signals from the microcontroller are not analyzed. In the menu can be set if the DCF module is with low or high on.

Tested modules

Module	GND	VCC	DCF input	PowerSave output	Comment
Conrad DCF Modul	1 (GND)	2 (Betriebs...)	3 (DCF Ausgang)	-	
ELV DCF Modul	3 (Masse)	1 (+ UB)	2 (Signal-Ausgang)	-	
Pollin DCF Modul	GND	VCC	DATA	PON	Caution An additional circuit is required for an operating voltage of more than 3.3V!

Our standard color coding for DCF signals

- GND: black
- VCC: rot
- DCF input: green
- PowerSave output: white (is not supported by each DCF receive module)

You can usually also supply the DCF receiver via the PowerSave output. But in this case you must ensure that this output is not inverted in the menu and that the pin must not be permanently loaded with more than 20 mA.

Connect the DCF module with approx. 10 cm wire, it is best to select the colors as in the table above, so that this can be mounted at some distance from the display.

WARNING	
Please check the pin assignments! It is not in our hands whether the manufacturers of the DCF receive modules change the pin assignments at a later date.	

Connection of the DCF module using a fake module

Here you will find some examples for the wiring of the DCF modules, as already mentioned, some strands are intended for wiring.

Without Power On / Off or Power Save input

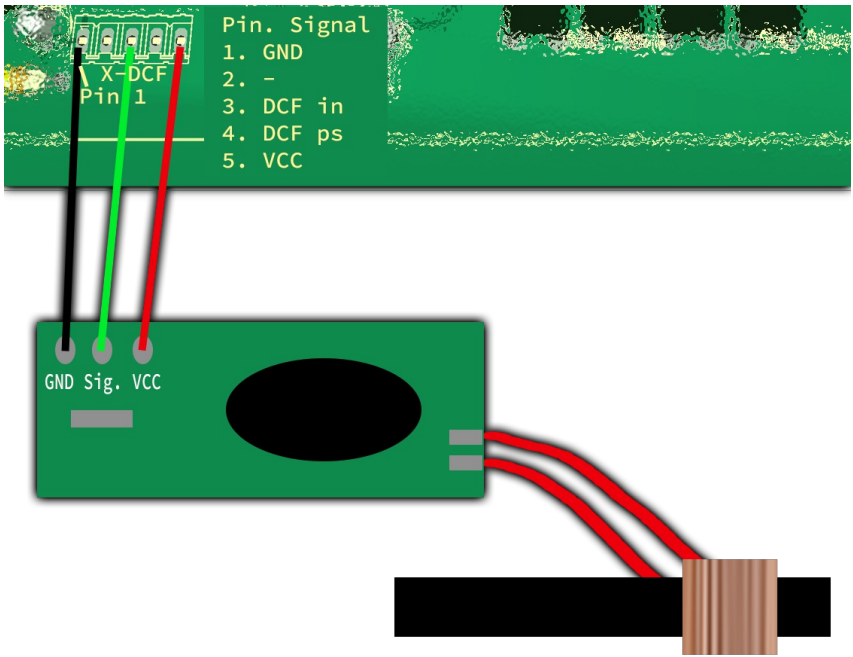

Figure 19: DCF connection to VCC

In the figure above you can see the classic wiring of the 5-pin pin strip and the DCF receiver module. Here the receiving module is permanently supplied with 5 volts or VCC and therefore also permanently supplies a signal.

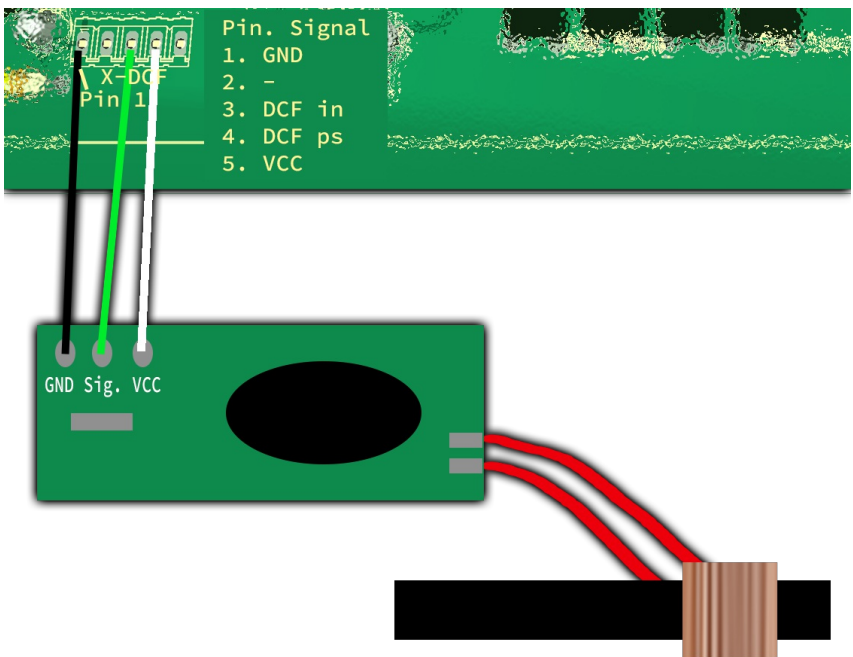

Figure 20: DCF connection with PowerSave

In this figure above you can see a wiring with the PowerSave signal as VCC for the DCF receiving module. Here the receiving module is only supplied

with voltage while the analysis is being carried out. When using this, make sure that the setting in the DCF menu does not invert the PowerSave output (see "Power save pin invert")!

With Power On / Off or Power Save input

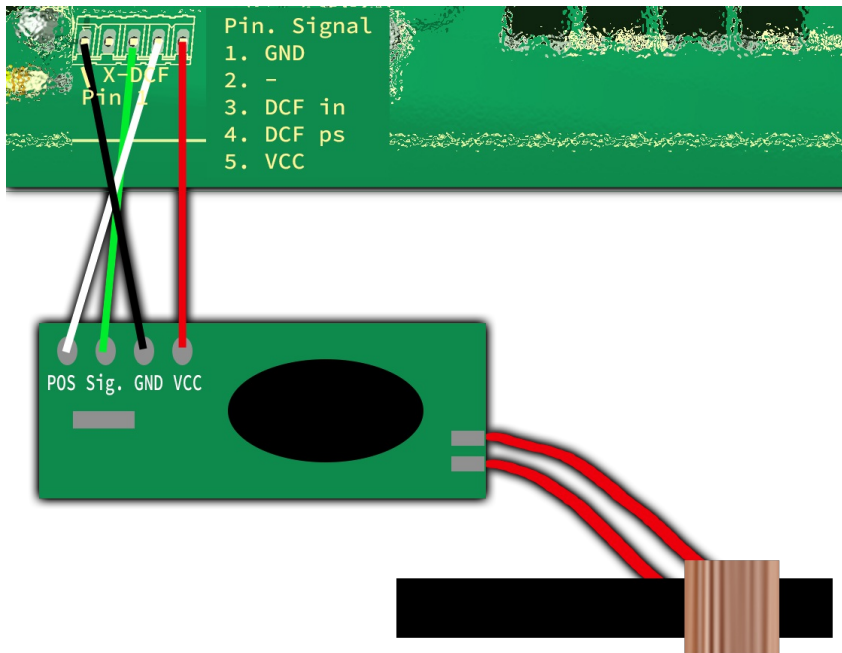

Figure 21: DCF connection with VCC and PowerSave

Here you can see the wiring with VCC and the PowerSave signal. Here the receiving module is only switched on while the analysis is being performed. A supply of voltage is permanent.

Power supply properties

Since the clock is usually to be operated on a 230 volt power supply, a power supply unit is required. This can be a normal transformer power supply or a switching power supply.

Transformer power supply:

- Pro:
 - Cheap
 - Little interference for DCF reception
- Contra:
 - Heavy
 - Depending on the power is it big
 - Poor efficiency
 - Even if the circuit requires little power, some power may be needed
 - Higher electricity costs

Switching Power Supply:

- Pro:
 - Light
 - Small
 - Good efficiency is possible
 - Standby possible with very low power requirements
 - Lower electricity costs than with the transformer power supply
- Contra:
 - Larger interference for DCF reception
 - Usually a little more expensive

Switching power supplies should be preferred, unfortunately they have the disadvantage that many can interfere with the DCF reception and the DCF clock is not synchronized. Switching power supplies with a PE feedthrough (PE is connected to ground) often have better interference behavior, but this cannot be generalized. The switching power supplies offered in our shop have been tested and only minimally interfere with DCF reception.

WARNING

Use only a power supply unit with electrical isolation!

Quartz - Accuracy of the time

The quartz, microcontroller, quartz capacitor combination decisively determine the accuracy of the clock. Since the kit is delivered unassembled, prior coordination is not possible and only uncalibrated accuracy is ensured.

The supplied accuracy is completely sufficient for normal use if the clock is synchronized daily with the DCF time.

The accuracy can be measured on the TB pin, which can be found in the pin assignment in the corresponding data sheet for the IC. If the clock is inaccurate, first check the soldering points of the quartz, the quartz capacitors and the controller. These solder points must be correctly soldered and dirt such as Flux should be removed.

You can carry out a calibration yourself with the appropriate measuring equipment or you can order it from us with cost. Check the [items in our shop](#).

To carry out the calibration, measure on pin TB with a multimeter, which frequency or period measurement can or with a frequency meter the output frequency. This should be as accurate as possible at 1 kHz or 1ms (for period measurement). A long gate time (duration of the frequency measurement) is advantageous because the interrupts create a little jitter (slight variation in the frequency). The calibration can be done digitally in firmware in somewhat rough steps in the menu "Calibrate quartz" or with a trim capacitor (this is not listed in a kit or parts list) in very fine steps. The best result is achieved by a trimming capacitor. However, since these are rarely produced, they are expensive and the increase of accuracy is minimal. Furthermore, for trimming capacitors you need a good tactile adjustment tool, a "normal" screwdriver usually does not work.

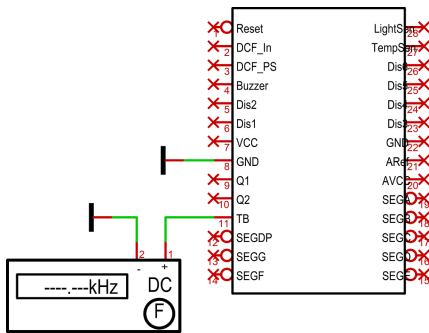

Figure 22: Calibrate quartz

NOTICE

Of course, the measuring device must have a corresponding accuracy.

Buzzer to MP3 player

If an MP3 player is to be used instead of a self-exciting buzzer, a small circuit must bridge the signal off time.

This is possible with this very simple circuit, with a NE555, build-up as a retriggerable mono-flop.

Furthermore, there is a small power supply for the MP3 module, because most of the imported modules requires a voltage supply of 5 volts. The current is still acceptable with a connected 4 Ohm loudspeaker for a 7805 with heat sink and a current of 200 to 500 mA, since the alarm should not play for more than 30 min. However, it is also possible to use a PIN compatible DCDC converter by different manufacturers.

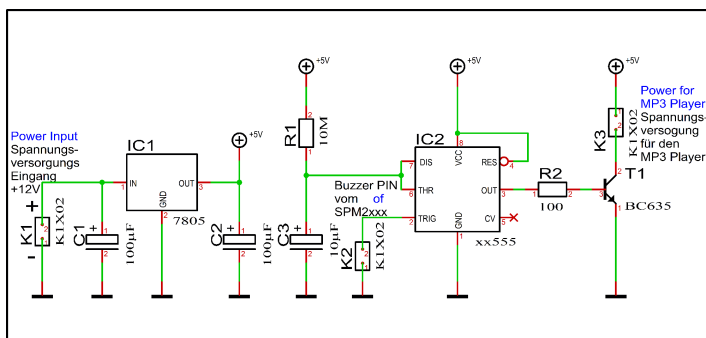

© StefPro™ Stefan Nannen 2016

TITLE: Buzzer2MP3

File name: Buzzer2MP3.T3001

Change date a. time:	Output date a. time:	Scale:	REV:
11.12.16 11:00	11.12.16 11:09	220,89%	RevA01

Document Number: SPM2100-B2MP3 **©StefPro™** Sheet: 1

Combination R1 and C3 gives a mono time of approx. 2 min.

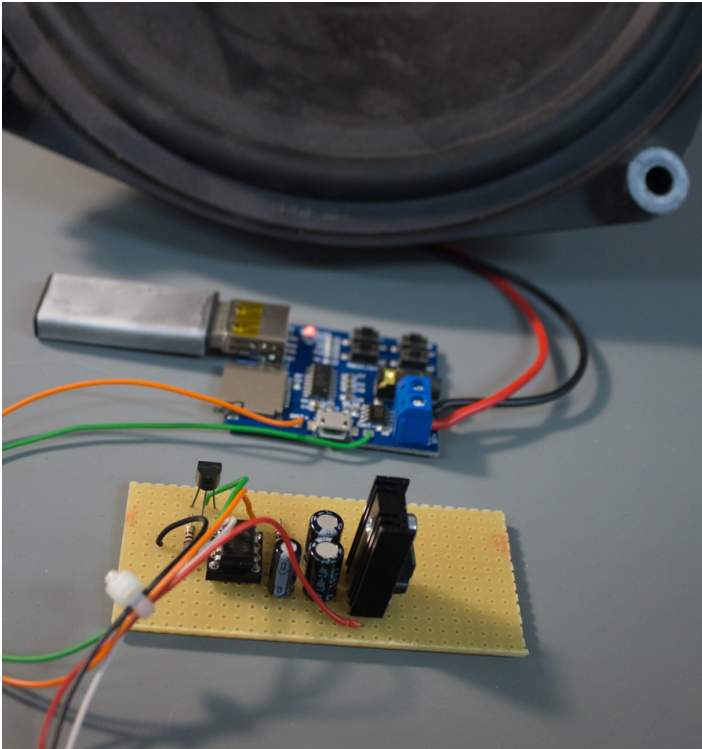

Colors of thin wires:

- red: plus supply voltage ($\leq +12$ Volt)
- black: minus supply voltage
- white: Buzzer signal from the IC SPK2121.01
- orange: plus MP3 Player Module (+5 Volt)
- green: minus MP3 Player Module

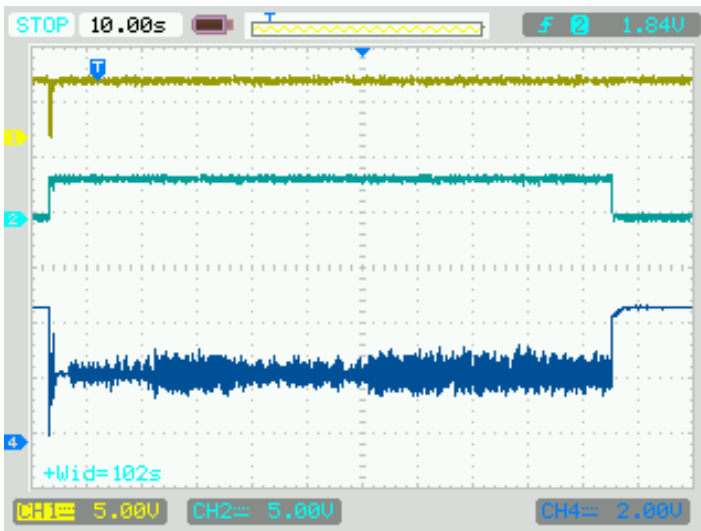

Colors of the signals:

- yellow: Trigger signal
- light blue: MP3 Player Power Supply
- dark blue: Output from the MP3 Player

Properties of light sensor with Phototransistor

The light sensor is used to control the brightness of the display. As light sensors many phototransistors are suitable, in the example circuit a BPW42 is used. If another phototransistor is used, you may need to change the value of the pull-up resistor R1. The menu allows to adjust the calculation factor, offset and the control speed. If the sensor is mounted behind a contrast panel, it must be taken to ensure that the wavelength of the phototransistor can pass through the contrast screen.

The calibration only refers to the offset, the linearity cannot be changed!

Installation the DCF clock

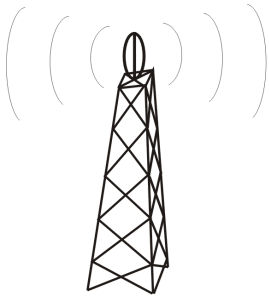

Sender in Frankfurt



DCF77-Antenne

Figure 23: Align the DCF antenna

The external antenna receives the DCF77 signal and should be directed to Frankfurt, as shown in Figure 23. The antenna should be placed at least 1 meter away from a monitor, computer or other disturbing electronic devices .



During installation, the receiving LED can be used as an orientation to the quality of reception. The LED should flash at intervals of one second. If the antenna is properly aligned and the signal is strong enough, the display changes of „no signal,, (No impeccable DCF77 signal) in „SEArCH,, (search for the 59th second). Was the 59th second found so will the display shows „rEAd60,, (read the DCF time) henceforth. It still takes 60 seconds to display the correct time. If the clock is not synchronized to the DCF time, the receiver LED flashes DCF work cycle (power reserve is in operation), if the LED is enabled in the menu. Is the display not changed to „SEArCH,, the antenna is probably disturbed by a device or the antenna is too close to the display. Because the DCF antenna is so sensitive that it can disturb by the display in the near field, there is the possibility to reduce the brightness of the display during the synchronization, or to deactivate the display. This problem have all other DCF clocks with multiplexed LEDs displays also. By a darker display the DCF antenna can be mounted significantly closer to the display.

Synchronize with active display

This mode is active when in menu under "receive brightness" the brightness is set > 0. Appearance of the text on the screen:



Synchronize with deactivated display

This mode is active when in menu under "receive brightness" the brightness is set to 0. When synchronizing with disabled display, only one decimal point for orientation appears.





„**SEArCH**„ Search the fifty-ninth second.



„**rEAdXX**„ read the dcf time.

Emitted electrical disturbances by the display

In the near field generates the display, by the fast on and off switching of the LEDs, disturbances. These depend on the brightness of the display. For EMC / CE conformity these disturbances are uninteresting because they are strong only in the near field and occur only under 30 MHz. For sensitive antennas as a DCF77 antenna these disturbances may be problematic, because this increases the distance between the antenna and the display.

To illustrate, a few simple relative measurements were performed with an oscilloscope:

Test setup

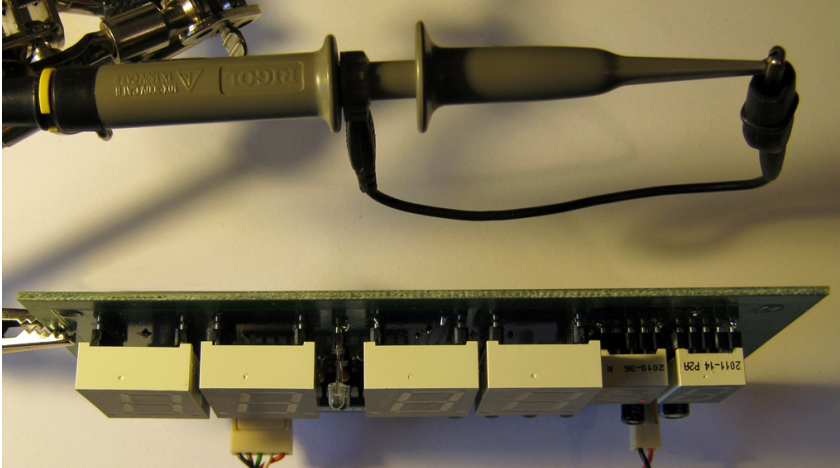

Figure 24: Test setup for the measurement

Measurement results

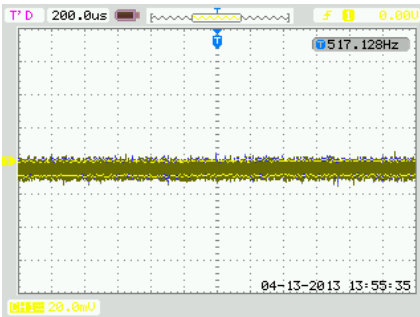

Figure 25: Measurement display is switched off

Figure 25 the display is off, only a decimal point indicates the synchronization status of the DCF time. The "Receive brightness" is on brightness level 0

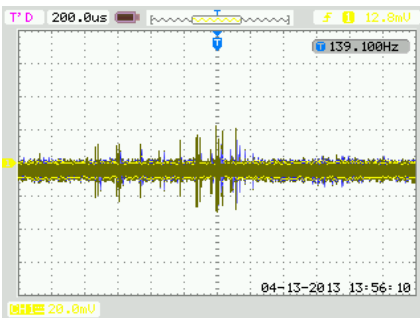

Figure 26: Measurement with brightness level 15

Figure 26 shows the display brightness set to 15 and there will be something displayed. It can be seen slight disturbances in the near field.

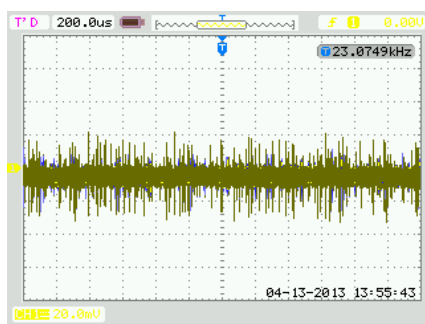

Figure 27: Measurement with brightness level 25

Figure 27 shows on the display brightness set to full brightness level 25 and it will be something displayed. There can be seen big disturbances in the near field.

The measurements were performed with an oscilloscope with 200 MHz bandwidth, a probe 10/1 (in order to obtain the full range) and PeakDetect. It was used the circuit SPP2100.

NOTICE

Instead of the previously described half multiplexed circuit, only the simple on-chip circuit is shown. This has similar pictures but is slightly lower in level.

Button description

Overview of buttons

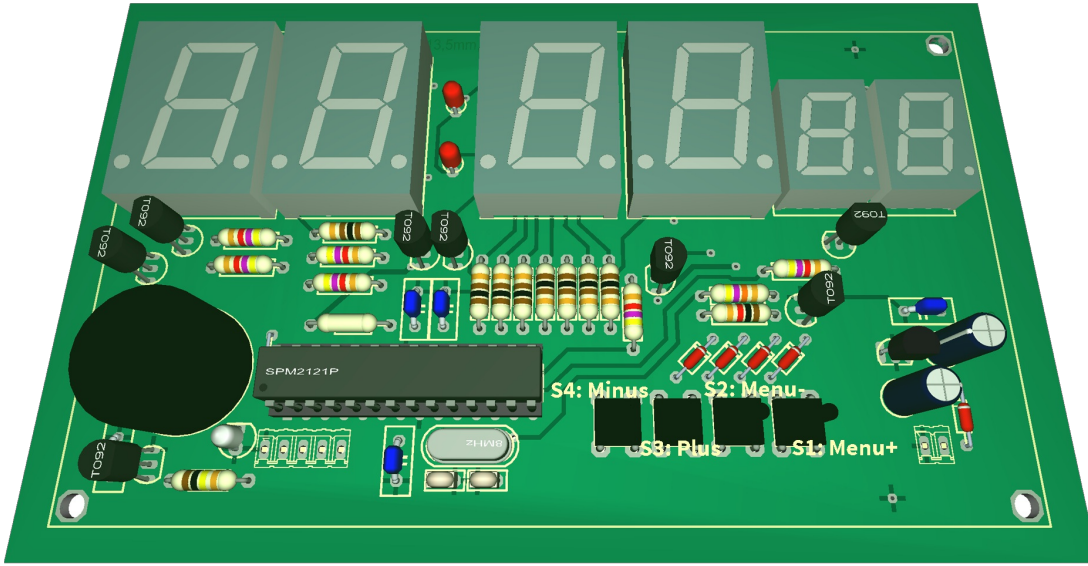

Button functions

- Menu+ Opens the menu, next setting
- Menu- Opens the menu, previous setting
- Plus or + Function key, usually +, On or jump into and exit a submenu
- Minus or - Function key, in general - or off

To open the menu you have to press one the menu buttons. Use the menu+ button to navigate forward and the menu- button to navigate backward.

General key functions

- A submenu is always opened with the "Plus" or "+" key and with menu display "... E" it can be exited again with "Plus" or "+".
- For numerical properties, the number is increased with the "Plus" or "+" key and decreased with the "Minus" or "-" key.
- If it is an On / Off property, then "Plus" or "+" sets On and "Minus" or "-" sets Off.
- With lists, the value is changed according to the order with the "Plus" or "+" button, with "Minus" or "-" this happens in the opposite way.
- In special cases, this is described in detail next to the images.

Menu

Level 1	Level 2
Normal ↓	
Display mode of clock ↓	
Show Temperature ↓	
Alarm ↓	Alarm enable → Alarm time hour → Alarm time minute → Alarm snooze time → Alarm sound wait time → Alarm maximum time → Alarm exit ⏪
Brightness ↓	Brightness menu → Brightness max → Brightness min → Brightness automatically → Brightness speed → Brightness factor → Brightness offset → Activate standby → StandBy start hour → StandBy end hour → StandBy Brightness → Exit brightness settings ⏪
DCF ↓	DCF active → Receiving brightness → Hour of synchronization → Receive state display → DCF input pull up → DCF input invert → Power save pin invert → DCF sensitivity → DCF exit ⏪
Clock Settings ↓	Set hour → Set minute → Set year → Set month → Set day → Day of week → Set time → Calibrate quartz → Exit clock settings ⏪

Level 1
Info section ↓
IC number ↓
Firmware version ↓

Level 2

↓: Next step in main menu.

→: Next step in sub menu.

↺: The submenu starts again.

Normal

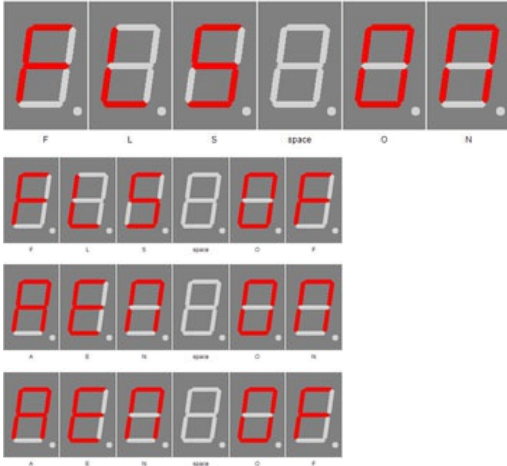

Normal mode, outside of the menu.

Here the plus (+) button has the function of the alarm temporary switch on or off.

The minus (-) key switches the display back to 100 % (flashlight, automatic brightness control is switched off) or to normal brightness.

Display mode of clock

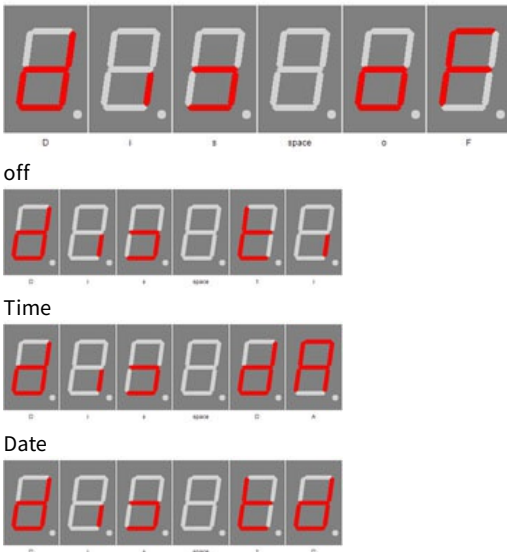

Use plus (+) and minus (-) to set the mode how to display time and date.

- OF: Does not display the time / date. When the temperature display is active, the temperature is displayed continuously. If no temperature display is possible or active, dashes (-) are shown in the display.
- ti: Shows only the time.
- dA: Shows only date.
- td: Shows time and date alternately.

NOTICE

If the temperature display is active, always alternate with it.

Show Temperature

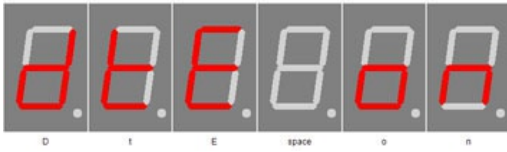

Display temperature on



Display temperature off



Temperature calibration

Enables the temperature display. Plus (+) enables the temperature display and minus (-) disables it.

Long press plus (+) activates the calibration via temperature input, long press - activates the calibration via offset value. You can find more information in the chapter "Temperature sensor" - "Method of calibration ...".

Alarm

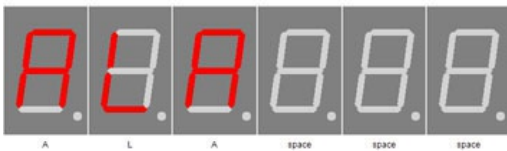

ALARM

Alarm enable

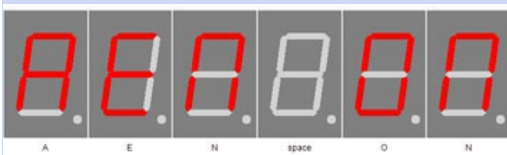

ALARM ON



ALARM OFF

With plus (+) you enter the sub-menu Alarm.

Enables the alarm. Plus (+) sets the alarm to "AEN ON" and minus (-) sets it to "AEN OF".

Alarm time hour

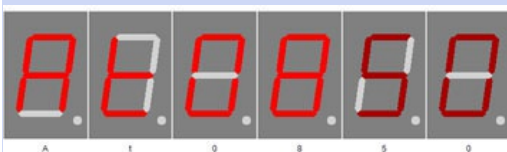

Alarm hour

Use plus (+) and minus (-) to set the hour for alarm. The number can be 0-23

Alarm time minute



Alarm minute

Use plus (+) and minus (-) to set the minutes for alarm. The number can be 0-59

Alarm snooze time

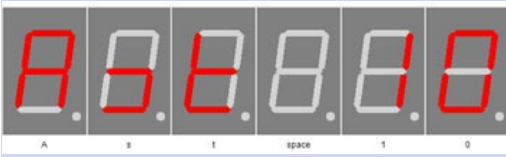

Alarm snooze time

Use plus (+) and minus (-) to set the minutes for the snooze function. The number can be 1-30

NOTICE

If "alarm maximum time" is shorter than alarm snooze time, the snooze function is disabled!

The snooze function can be activated in alarm/wake-up mode with plus (+) and minus (-) and the alarm can be stopped with the menu buttons.

Alarm sound wait time



Alarm sound delay

Use the plus (+) and minus (-) buttons to set the maximum alarm duration in minutes. The number can be 0 - 10.

NOTICE

If "Alarm sound delay" greater selected as maximum alarm time, then the display is only set to 100% brightness! No buzzer alarm!

Alarm maximum time

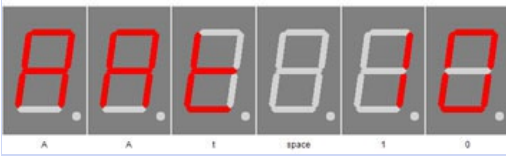

Alarm after time

Use plus (+) and minus (-) to set the maximum time in minutes for the alarm. The number can be 2-60.

Alarm exit

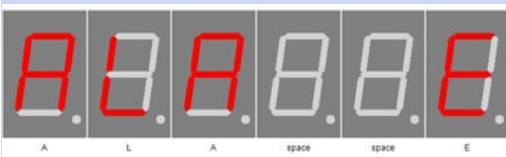

Alarm exit

With Plus (+) you exit the sub-menu alarm.

Brightness

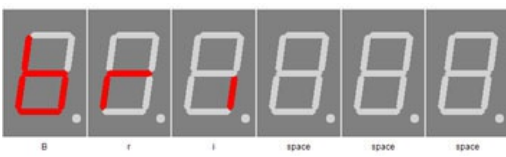

Brightness

With plus (+) you enter the sub-menu brightness.

Brightness menu



Brightness

Sets the brightness of the menu. The number can be between 10 and 25, with 10 being the darkest menu and 25 the lightest.

Brightness max



Brightness high

In this menu item, the maximum brightness plus (+) and minus (-) of the display can be adjusted.

This is also used when auto brightness is disabled.

The number can be between 0 and 25, with 0 being the darkest and 25 the lightest.

Brightness min



Brightness low

In this menu item, the minimum display brightness can be adjusted with plus (+) and minus (-).

The number can be between 0 and 25, with 0 being the darkest and 25 the lightest.

Brightness automatically



Brightness automatically on



Brightness automatically off

This allows to turn on with plus (+) and off with minus (-) the auto brightness.

Brightness speed



Brightness speed

Use plus (+) and minus (-) to set the speed of auto brightness.

The number can be between 0 and 20 and delays the brightness calculation by approx. 100 ms. With the setting 20, the brightness is therefore recalculated every 2 seconds. The maximum value may differ depending on the firmware.

Brightness factor



Brightness factor

Use plus (+) and minus (-) to set the calculation factor for auto brightness.

The number can be 1-99. There is no unit for this, as it cannot be defined due to component tolerances.

Brightness offset



Brightness offset



Brightness offset -99



Brightness offset +99

Use plus (+) and minus (-) to set the calculation offset for auto brightness. The number can be between -99 and 99. There is no unit for this, as it cannot be defined due to component tolerances.

Activate standby



StandBy (Powersave) Enable On



StandBy (Powersave) Enable Off

With plus (+) activate and minus (-) deactivate the standby mode, in this case the display is switched off or darkened. This depends on the "standby brightness". The clock and alarm function are still available, the time, date or temperature are simply not displayed.

Through the flashlight function can this interrupted.

StandBy start hour



StandBy (Powersave) Start Hour

The standby operation starts from this hour. Only full hour can be set by plus (+) and minus (-).

The range is from 0 (midnight) to 23 (11pm).

StandBy end hour



StandBy (Powersave) Finish Hour - Endstunde

From this hour on, standby operation ends. Only full hour can be set plus (+) and minus (-).

The range is from 0 (midnight) to 23 (11pm).

StandBy Brightness



StandBy (Powersave) Brightness level 1

Use plus (+) and minus (-) to adjust the brightness of the display in standby mode, 0 means off.

The range is 0 to 90, but 90 corresponds to 9 of the other brightness settings in this menu.

Exit brightness settings

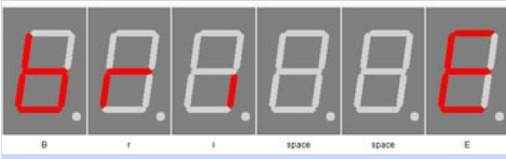

With plus (+) you exit the sub-menu brightness.

DCF

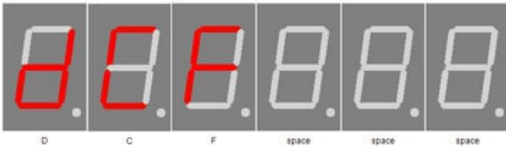

With Plus (+) you enter the sub-menu DCF.

DCF

DCF active

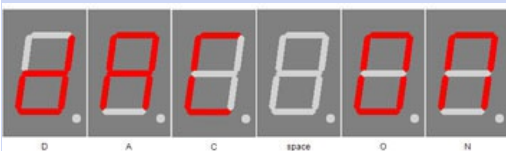

DCF active on



DCF active off

Use plus (+) and minus (-) to set whether or not DCF reception is active. If the DCF reception is deactivated, the clock only works with the built-in quartz clock. Note that in this case the time base must be set as well as possible.

Receiving brightness

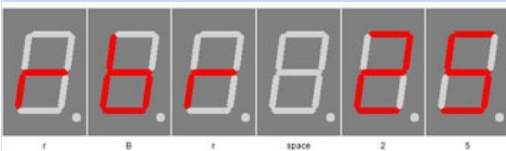

Receiving brightness

Use plus (+) and minus (-) to set the brightness during the DCF receiving. If 0, the display is turned off and the status of the synchronization is shown by decimal points. The number can be 0-25.

Hour of synchronization

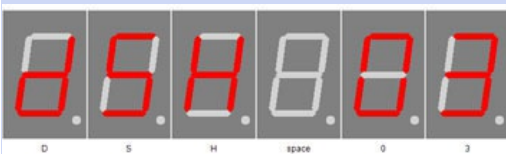

DCF synchronize hour



DCF synchronize hour disabled

Use plus (+) and minus (-) to set the hour in which the DCF clock will synchronize. In this hour, the DCF signal will be analyzed until a synchronization has occurred or the hour changes.

The number can be 0-23.

If the display shows "--" instead of a number, the synchronization hour has been deactivated and the dcf receiver is constantly trying to synchronize. In this case, the receipt display can also be displayed permanently.

Receive state display



DCF status decimal point display

Use plus (+) and minus (-) to set the mode for the receive LED, which shows the received signal. The number can be 0-2.

- 0: Only until the clock has been synchronized.
- 1: Shows the received signal when the clock is not synchronized with the DCF77 signal.
- 2: During the synchronization phase, the receive signal is always on the receive LED regardless of the DCF77 synchronization flag.

Only while the clock is trying to receive the DCF signal, see "Hour of synchronization".

DCF input pull up

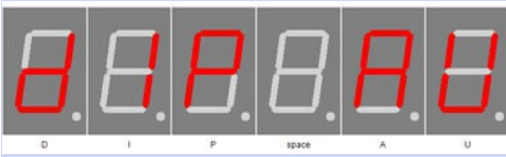

DCF input pull up auto



DCF input pull up on



DCF input pull up off

DCF input invert

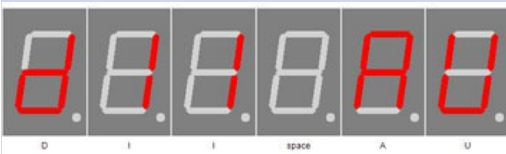

DCF input invert auto



DCF input invert on



DCF input invert off

Power save pin invert

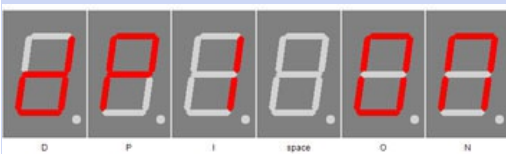

DCF powersave invert on



DCF powersave invert off

DCF sensitivity

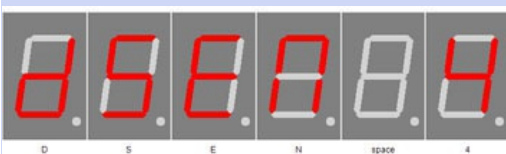

DCF sensitivity

DCF77 input pin with pullup

- AU: Pull Up is automatically (default).
AU is activated by pressing the plus (+) button.
- ON: Enables the pull-up resistor
- OFF: Disables the pull-up resistor
ON and OFF is activated and toggled by the minus (-) button.
- Conrad DCF module = ON
- ELV DCF module = ON
- Pollin DCF module (3.3 V) = OFF

No guarantee for correctness of the information and changes of the manufacturer.

DCF77 inverting the input pin

- AU: input is automatically inverted or not (default).
AU is activated by pressing the plus (+) button.
- ON: Input inverts
- OFF: no input inverted
ON and OFF is activated and toggled by the minus (-) button.
- Conrad DCF module = for PIN3 ON, PIN4 OFF
- ELV DCF module = ON
- Pollin DCF module (3.3 V) = OFF

No guarantee for correctness of the information and changes of the manufacturer.

If the receive LED is off every second, the setting must be inverted.

Inverts DCF77 power On / Off output, plus (+) enables inversion and minus (-) disables it:

- ON: Power ON / OFF output is inverted (module ON at GND)
- OFF: power on / off output is not inverted. (module ON at VCC)
- Conrad DCF module = No power on / off input pin available
- ELV DCF module = No power on / off input pin available
- Pollin DCF module (3.3 V) = ON

No guarantee for correctness of the information and changes of the manufacturer.

Read the instructions of the receiver module for the power on / off pin of the DCF module to set this setting correctly. Many modules do not have this pin, then this setting can be ignored.

Use plus (+) and minus (-) to set the DCF Sensitivity. 1 has a very low tolerance and 6 has the highest tolerance for reception. The Sensitivity should be set as small as possible to avoid incorrect receiving. The number can be 1-6. Tolerance means the deviation from the high and low of the time signal, i.e. 100 or 200 ms of the DCF signal.

DCF exit

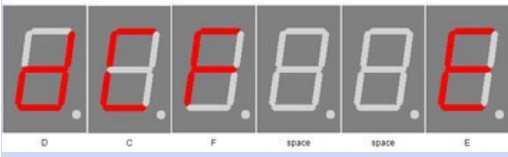

DCF Exit

With plus (+) you exit the sub-menu DCF

Clock Settings

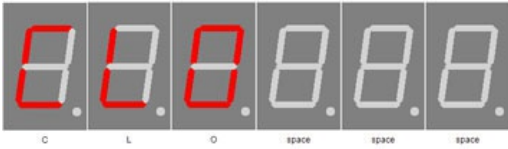

clock

With plus (+) you enter the sub-menu clock.

Set hour



change time

Use plus (+) and minus (-) to set the hour.
The number can be 0-23.

Set minute



change time

Use plus (+) and minus (-) to set the minute.
The number can be 0-59.

Set year

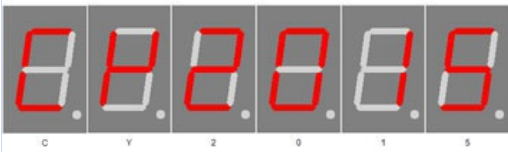

change year

Use plus (+) and minus (-) to set the year.
The number can be 2000-2099.

Set month



change month

Use plus (+) and minus (-) to set the month.
The number can be 1-12.

Set day

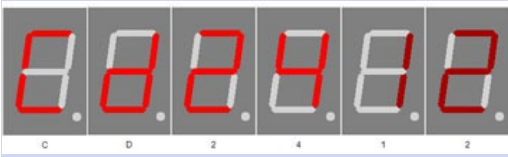

change day

Use plus (+) and minus (-) to set the day, limit by month.
The number can be 1- 28, 29, 30, 31.

Day of week



Monday - Montag



Tuesday - Dienstag

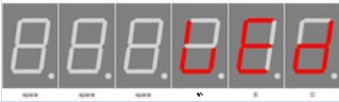

Wednesday - Mittwoch



Thursday - Donnerstag



Friday - Freitag



Saturday - Samstag



Displays the day of the week from the set date.

Set time



Set settings

Plus (+) sets the time, while looking for DCF time, otherwise the time will be provided directly.

Calibrate quartz



Calibrate quartz +10



Calibrate quartz -10

Exit clock settings

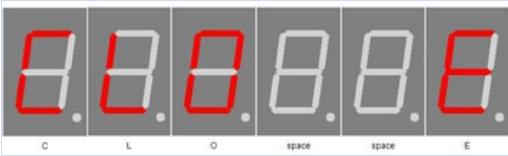

Clock end

With plus (+) and minus (-) the quartz can be calibrated, a positive value increases the period time and a negative value reduces it. The period should also be set as precisely as possible to 1ms or 1kHz (for frequency measurement). The measurement must be carried out on pin TB. Further information can be found in the chapter [Quartz properties - Accuracy of the time](#).

With plus (+) you exit the sub-menu clock. Until here the clock, without DCF synchronization, will be taken and used until the next scheduled synchronization.

Info section

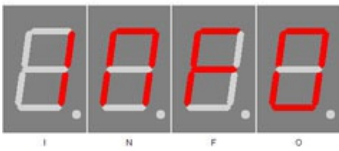

This indicates the start the information area

IC number

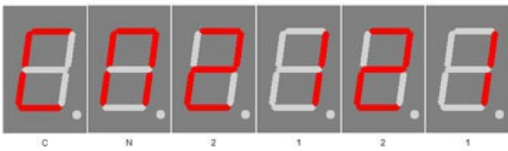

Chip number

IC / device type

Firmware version



Firmware version

Firmware version

Example, it might be something else at this point.

Menu end

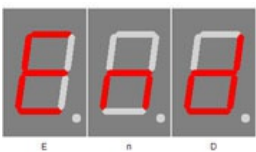

End

End of the menu, hide automatically after 2 seconds.

Attachment

Bootloader handling

Start the IC/module/device in bootloader mode

1. Switch off the IC/module/device.
2. Connect the UART adapter (USB → 3.3 volts or 5 volts UART or RS232 → 3.3 volts or 5 volts UART).
"DCF in" → UART adapter TXD and "DCF ps" → UART adapter RXD.
3. Press the button S1, power up the IC/module/device with voltage and do not release this button until you hear a short BEEP. The display is off.
4. Now you can connect to the firmware upload tool.



Wrong UART level

If an incorrect voltage level (for example directly RS232, ± 12 Volt) is used, the UART adapter or the IC/module/device can be damaged or destroyed. In the worst case, overheating and fire may occur!

NOTICE

Defect firmware

Defect firmware can be detected as follows: Every second a short BEEP.

Use the Firmware Upload Tool to upload an update

1. Download the latest upload tool from www.stefpro.biz: [SP Firmware UP](#)
2. Start the tool
3. Select the COM port.
4. Press the "Load" button and select a firmware which you have previously downloaded from SP Firmware UP
5. Now press the "Connect" button, the data from the IC / Module / device will be read and the compatibility of the new firmware with the IC / module / device will be checked
6. If an upload is possible, you can now press the "Upload Firmware" button. The upload starts and should not be interrupted.

NOTICE

Firmware upload interruption

If the firmware upload is interrupted or uploaded an inappropriate firmware, so there is a broken firmware, the IC can be operated only in bootloader mode.

7 segment characters

The symbolism of each character:

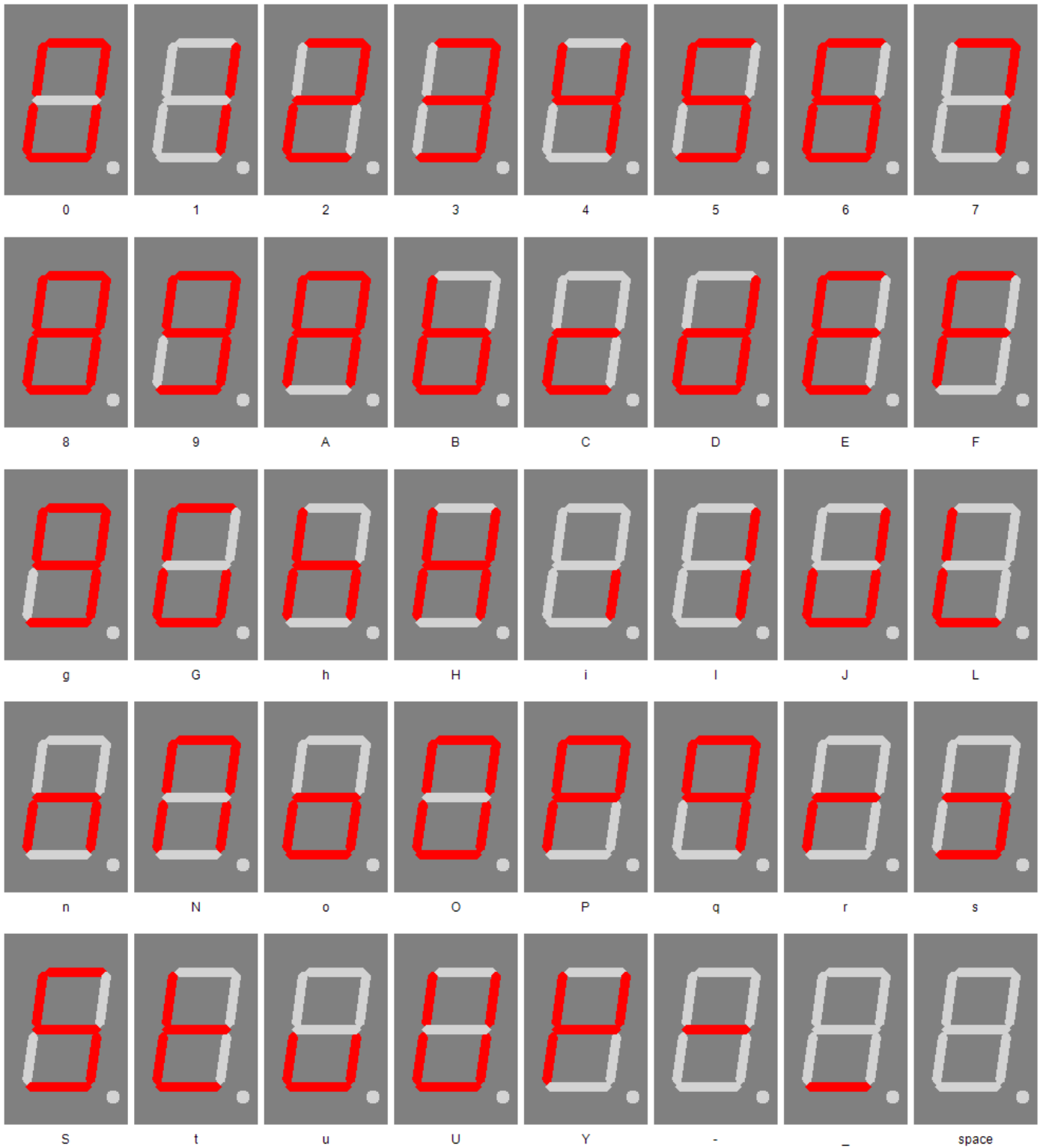

Change log

Safety

20.03.2017 - 1.0.3 - ADD
Add ESD note

DCF module properties

21.11.2016 - 1.0.1 - ADD

Add list of tested modules

20.03.2017 - 1.0.3 - ADD

Update list of tested modules, add standard pin assingment

Power supply properties

21.12.2019 - 1.0.5 - ADD

Add SNT description

Buzzer to MP3 player

09.12.2016 - 1.0.2 - ADD

Add buzzer to mp3 player change description

Temperature sensor

22.03.2021 - 2.0.1 - ADD

Add add temperatur sensor and calibration description

Set day

23.04.2017 - 1.0.4 - ERROR

Bugfix wrong title, this sets the day not the month.

Liability, warranty and copyright notice

Definitions

- „Kit“: A bare printed circuit board and associated components, which when assembled form a module.
- "Module": A PCB which is delivered without housing and is intended for installation.
- "Manufacturer of the whole device": The manufacturer of the whole device, the natural or legal person is mounted a device which can be made to function without special knowledge. E.G. Simple connection to the network via a euro, safety plug or by connecting to a power supply.

Liability

- Although the information contained in this document has been checked very carefully for accuracy and completeness, for errors and omissions can not be held liable. StefPro reserves the right to any time change any portion of the described hardware and software features.
- StefPro provides only specific "module" which is intended for installation. The "Manufacturer of the whole device" obliges to compliance to the relevant valid VDE, CE and EMC regulations. StefPro has verifies compliance with the requirements for this module random. Because the installation is not performed by StefPro, must additional inspection after installation of the modules by the "Manufacturer of the whole device". If anything is unclear, please ask a question using the contact form.
- There is no liability for damages incurred directly by or in the application of the "module", as well as for damage caused by chemical or electrochemical effects of water or generally from abnormal environmental conditions.
- "Kit" and resulting "modules" by StefPro may not be used in critical equipment. At disregard exclusively the responsibility of "Manufacturer of the whole device."

These include:

- medical devices for implanting or life obtained.
 - Critical equipment for space, aerospace and traffic.
 - Other important life components or systems, where an error is fatal.
- All devices developed with a "Modules" by StefPro must be the responsibility of the "Manufacturer of the whole device" sufficiently tested to detect any defects.

Safety Notes

- Since the built module is operated with an electrical voltage, the valid VDE regulations are complied with.
- Components and modules do not belong in the hands of children!
- The module complies with the requirements of protection class III.
- The "module" may NOT directly to line voltage (or voltage > maximum operating voltage) in any case! It can be fatal!
 - Whenever it is that safe operation is no longer possible, the module / device must be taken out of service and secured against inadvertent operation. This assumption is justified,
 - when the module / device has visible damage,
 - when the module / device has loose parts
 - when the module / device no longer works
 - after prolonged storage under unfavorable conditions (eg outdoors or in moist environments)

Watch for correct voltage and connection of the "module" Voltage and / or connection mistakes are beyond our control. Thus we can not assume any liability for damages arising out of it.

Intended operation

- The used electrical parts and components are designed for a temperature between 0 °C ... +45 °C, so the device may only be operated and stored in this temperature range. It is therefore intended for use within a building, which corresponds to the specified environmental conditions. During transport, the temperature may be between -10 °C ... + 50 °C.
- If condensation has formed during transport or storage, the modules must be acclimatized for approx. 2 hours before commissioning.
- It must not be operated in an increased dust, high humidity, explosion risk or aggressive chemical exposure.
- Ensure proper operation and connection. Operating and/or connection errors are outside our area. Unfortunately, we can not accept any liability for damages resulting of this.
- The improper operation of this module may result in damage of this module, personal injury or property damage.
- The safety instructions must be observed!
- The manufacturer is not responsible for all personal injury and property damage caused by improper operation.

Warranty

- StefPro warranty only for the Kit and their firmware. The warranty is exclusively limited for the replacement of the IC within the warranty period for obvious defects in the hardware, and programming error.
- Warranty does not extend the warranty period or starts a new period again.
- Additional or deviating claims are excluded, especially claims for damages arising out of the product for damage. This will not affect claims based on inalienable rules under the product liability law.

Copyrightnotice

The circuitry and firmware to the kit and module from StefPro are protected by copyright. Unauthorized reproduction or distribution of Modules with this program or any portion of it. This is pursued both criminal and civil law, and may result in severe penalties and compensation for damages.

Disposal information

Do not dispose devices in household garbage!

This modules or devices comply with the EU directive on electronic and electrical equipment (WEEE regulation) and therefore may not be disposed of with household waste. Dispose of the device over your local collection center for electronic equipment!



WEEE-Reg.-Nr.:

DE 58929072 (StefPro UG (haftungsbeschränkt) & Co. KG)

DE 78089358 (StefPro Einzelunternehmen bis zum 01.01.2015)

Impress

StefPro™ UG (haftungsbeschränkt) & Co. KG
- Softwareentwicklung für Prozessoren

Dipl. Ing. (FH) Stefan Nannen

Theilenmoorstr. 11

26345 Bockhorn – Germany

Phone: +49-4452-709175 (please note our [business hours](#))

Web:<http://www.stefpro.biz/>

E-mail: info@stefpro.biz